

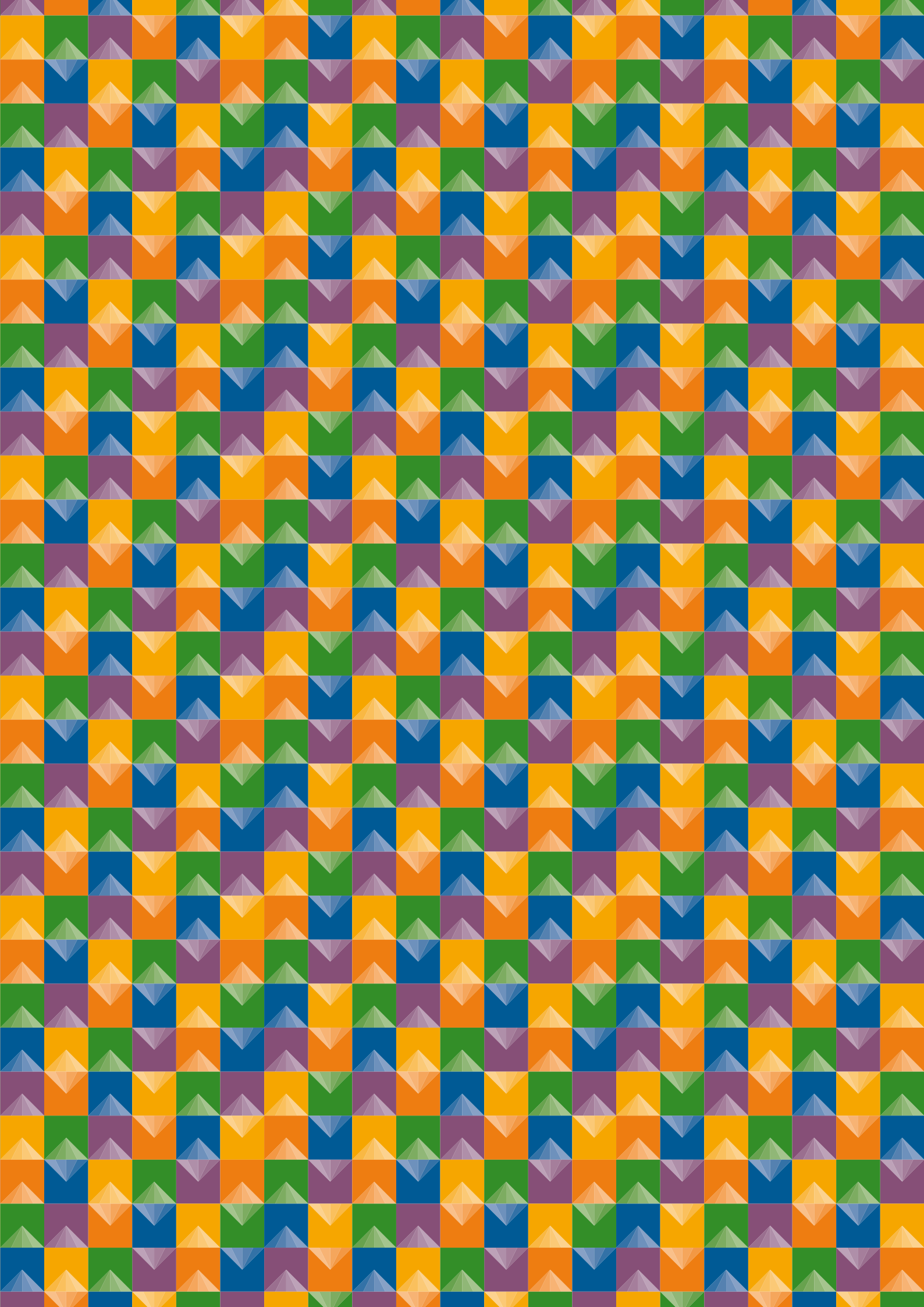

METER
ENVIRONMENT

2" ADAPTER MOUNTING & APPLICATION

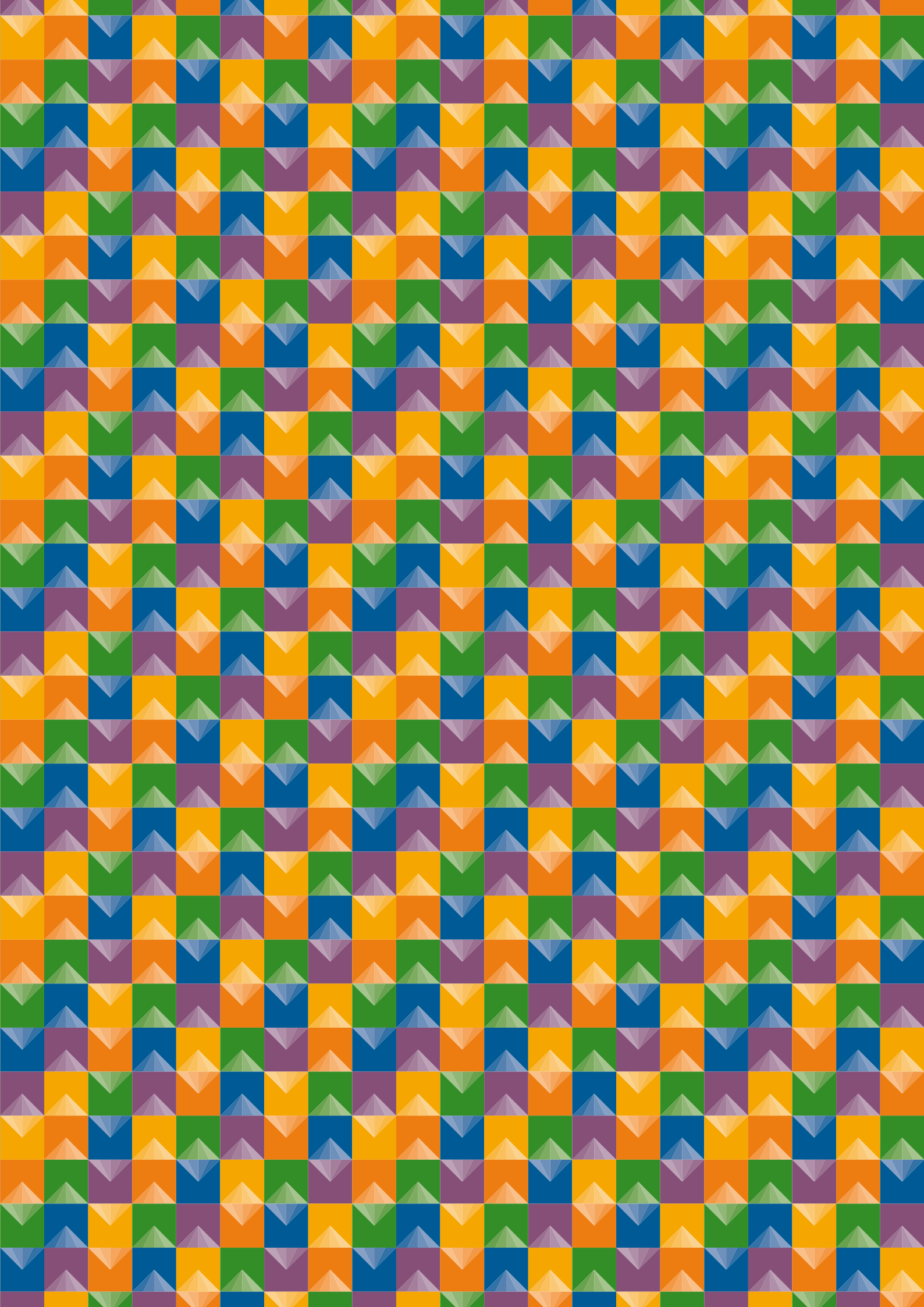



2" ADAPTER

MOUNTING & APPLICATION

| | |
|---|-----------|
| 1. MEASURING A 100 ML SOIL SAMPLE WITH KSAT AND ADDITIONAL HYPROP® | 7 |
| 1.1 SATURATING THE SOIL SAMPLE FOR KSAT MEASUREMENTS | 9 |
| 1.2 MOUNTING THE SAMPLE FOR KSAT MEASUREMENTS | 15 |
| 1.3 MOUNTING THE SAMPLE FOR HYPROP® MEASUREMENTS (OPTIONAL) | 19 |
| 2. MEASURING A 100 ML SOIL SAMPLE WITH HYPROP® | 23 |
| 2.1 SATURATING THE SOIL SAMPLE FOR HYPROP® MEASUREMENTS | 25 |
| 2.2 MOUNTING THE SAMPLE FOR HYPROP® MEASUREMENTS | 29 |
| 3. ACCESSORIES | 33 |

TABLE OF CONTENT

1. MEASURING A 100 ML SOIL SAMPLE WITH KSAT AND ADDITIONAL HYPROP[®]

1.1

SATURATING THE SOIL SAMPLE FOR KSAT MEASUREMENTS

SATURATING THE SOIL SAMPLE FOR KSAT MEASUREMENTS

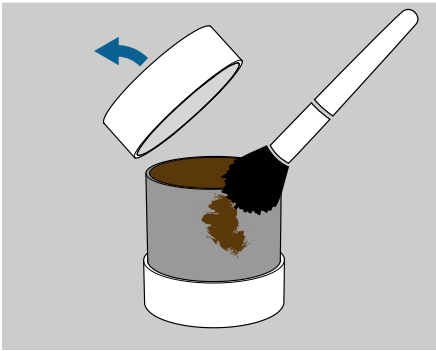

Weigh the adapter and note its weight. (This will be necessary for evaluation.)

Remove the lid from the sample ring (opposite of the cutting side) and clean the sealing area thoroughly.

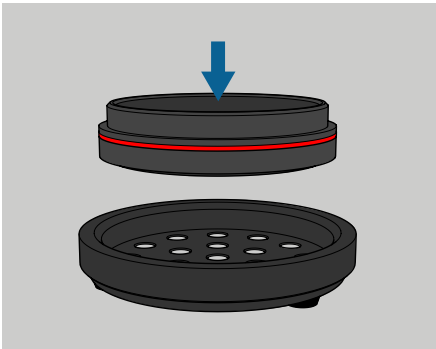

Put the red marked (smaller) part of the adapter with the marking line downward on the saturation plate, covered with a filter paper.

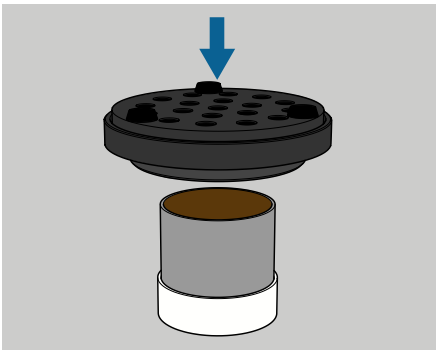

Flip the adapter and place it on top of the soil sampling ring.

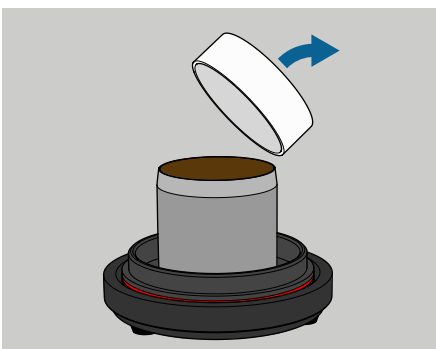

Turn the soil sample and remove the other lid. Place the soil sample in a water pan.

SATURATING THE SOIL SAMPLE FOR KSAT MEASUREMENTS

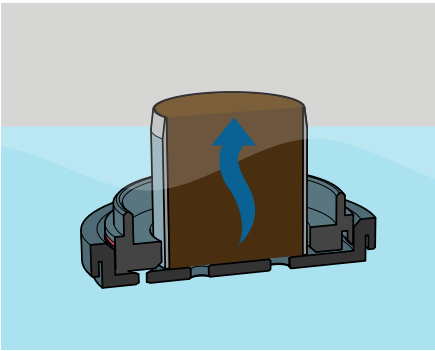

Fill the pan with water until it is just below the top of the sample ring (recommended times see below). Carefully tilt the sample including the saturation plate to let escape air bubbles.

Do not pour water on the sample – you may trap air.

TYPICAL SATURATING TIMES

| Material | fill up after | saturated after |
|-------------|----------------|-----------------|
| coarse sand | approx. 9 min | approx. 10 min |
| fine sand | approx. 45 min | approx. 1 hrs |
| silt | approx. 6 hrs | approx. 24 hrs |
| clay | n.a. | up to 2 weeks |

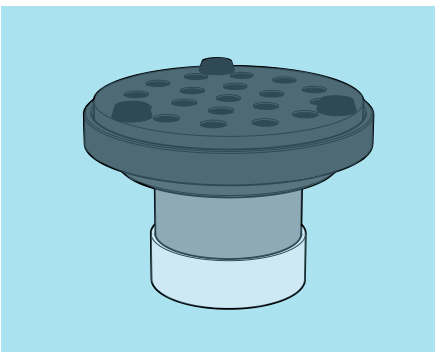

When the saturation is completed, close the soil sample with a lid, turn the whole system upside down and put it in a pan. (If there is only one soil sample in the saturation pan you can leave it there)

Fill the pan with at least 12 cm water so that the soil sample is completely covered with water.

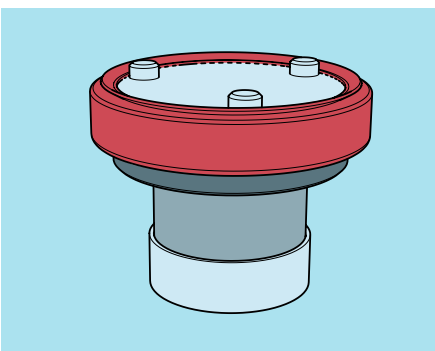

Saturate the porous plate of the red sealing (see note on next site) and put it in the same water filled pan.

Remove the saturation plate and the filter paper.

Be sure that the gap of the red marked part of the adapter is air free. Put the red sealing under water on top of the red marked part of the adapter.

SATURATING THE SOIL SAMPLE FOR KSAT MEASUREMENTS

NOTE:

The pores of the porous plate must be completely filled with water before being placed on the soil sample. You observe a complete saturation of the porous plate when it does not float in water, but settles.

If you want to use a dried out plate immediately, it is advisable to de-saturate it quickly under vacuum in a desiccator. Submerge the plate in water (with a weight on it to avoid floating) and evacuate the system. Then bring it back to atmospheric pressure.

If you keep the saturated plate horizontal you can move it as the water will be adhered in the pores. Avoid turning the plate into a vertical position. Gravity force will dewater the plate from the top.

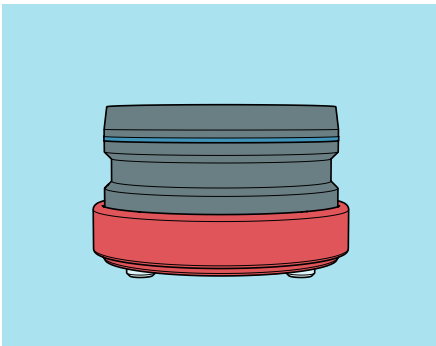

Turn the sample under water rightside up. Remove the other lid and put the blue marked (bigger) part of the adapter air free with the marking line upwards on top of the soil sampling ring.

SATURATING THE SOIL SAMPLE FOR KSAT MEASUREMENTS

1.2

MOUNTING THE SAMPLE FOR KSAT MEASUREMENTS

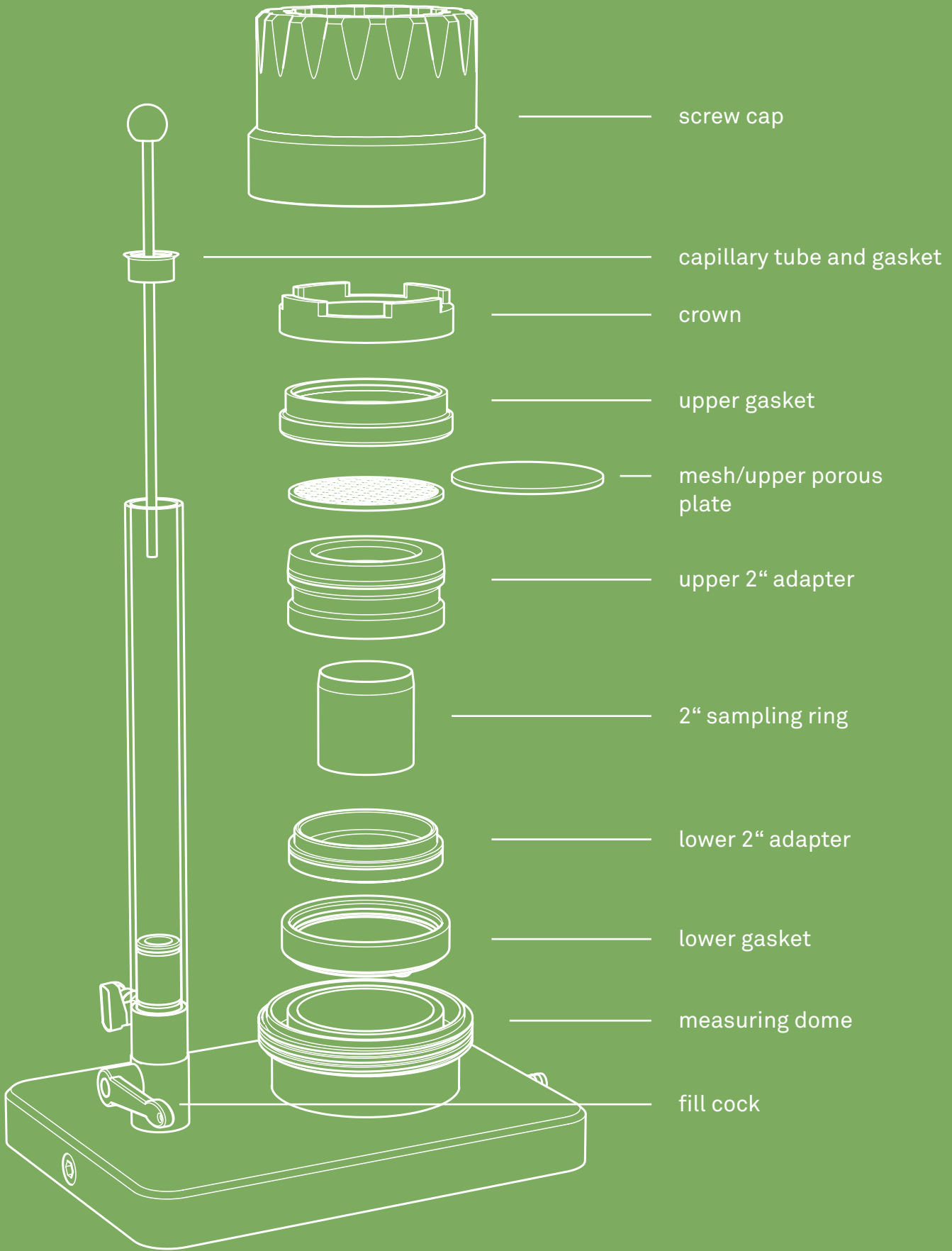

MOUNTING THE SAMPLE FOR KSAT MEASUREMENTS

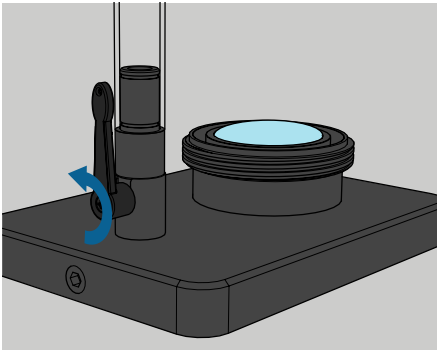

Open fill cock and fill burette.

Close fill cock, open burette cock and flood the measuring dome.

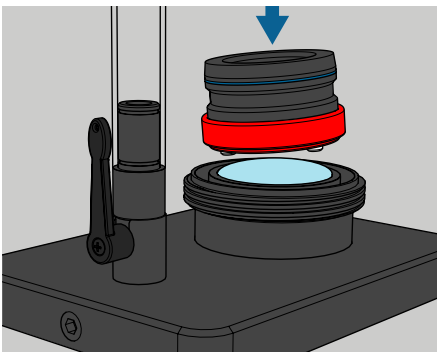

Close burette cock.

Take the soil sample out of the trough and move it horizontally to the device.

Put the sample slightly tilted on the water lense, allowing air to escape.

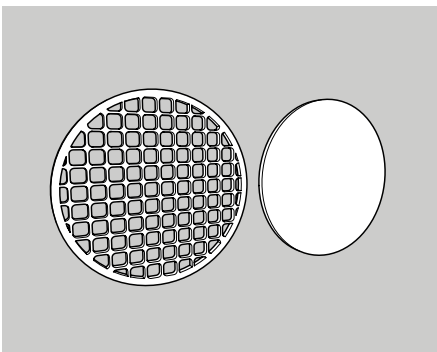

Please use mesh for consolidated materials and porous plate for non consolidated materials.

Adapt the software setup to your choice.

NOTE:

If the burette cock is closed when you mount the sample the rapid pressure increase may damage the pressure sensor in the device.

MOUNTING THE SAMPLE FOR KSAT MEASUREMENTS

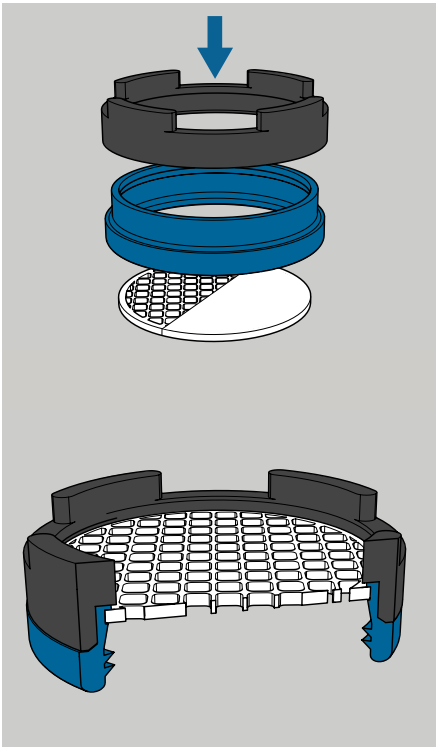

Press the porous plate or the mesh into the groove from the bottom of the blue gasket.

Place the crown from above on the blue gasket.

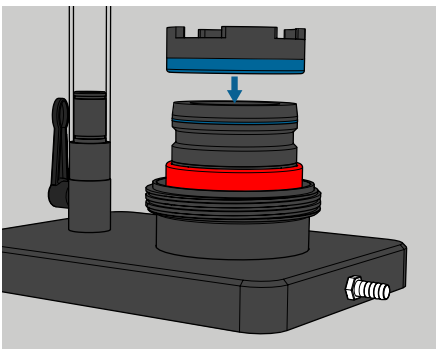

Press the whole set-up onto the sample ring in the KSAT.

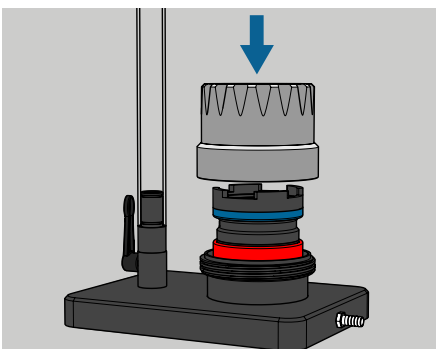

Fix the set-up with the screw cap.

The system is now ready for measurement. For instructions about the next steps please read the KSAT manual.

Be aware to change the required parameters in the software.

1.3

MOUNTING THE SAMPLE FOR HYPROP[®] MEASUREMENTS (OPTIONAL)



lower 2" adapter

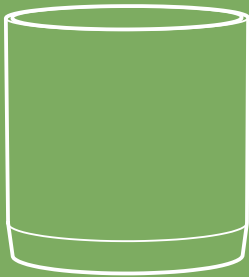

2" sampling ring

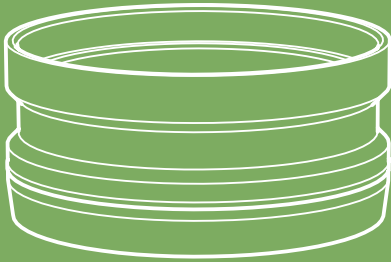

upper 2" adapter

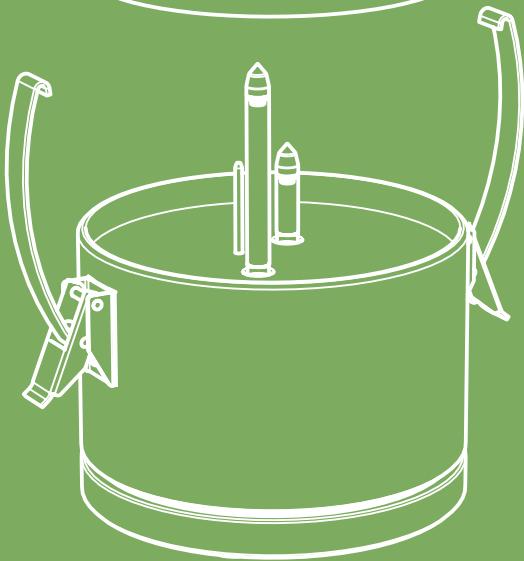

MOUNTING THE SAMPLE FOR HYPROP® MEASUREMENTS

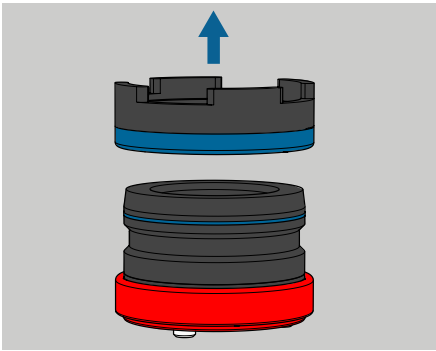

For continuing with a HYPROP® measurement open the burette cock and remove the system from the KSAT.

Remove the blue gasket and the crown.

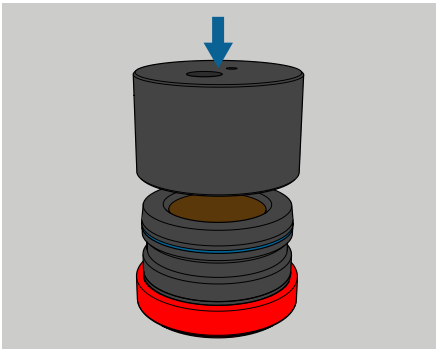

Put the auger guide on top of the blue marked part of the adapter for augering the holes for the tensiometer shafts.

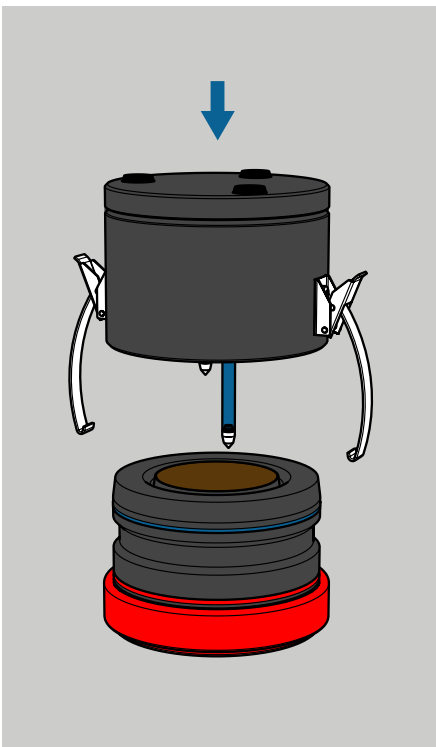

Put the refilled HYPROP® (for instructions about the preparation of the HYPROP® please read the HYPROP® manual) on top of the soil sample, turn the system upside down, remove the red sealing and close the HYPROP® clips.

Be aware that the gap between HYPROP® and adapter and on the surface is dry.

The HYPROP® is now ready for measurement. For further instructions please read the HYPROP® manual.

For evaluation with HYPROP FIT please insert the adapter's net weight into the flag „information“, „weight correction“.

MOUNTING THE SAMPLE FOR HYPROP[®] MEASUREMENTS

2.

**MEASURING A 100
ML SOIL SAMPLE**

**WITH HYPROP[®]
(OPTIONAL)**

2.1

SATURATING THE SOIL SAMPLE FOR HYPROP[®] MEASUREMENTS

SATURATING THE SOIL SAMPLE FOR HYPROP® MEASUREMENTS

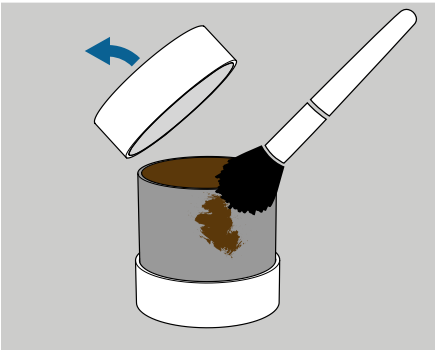

Weigh the adapter and note its weight. (This will be necessary for evaluation.)

Remove the lid from the sample ring (opposite of the cutting side) and clean the sealing area thoroughly.

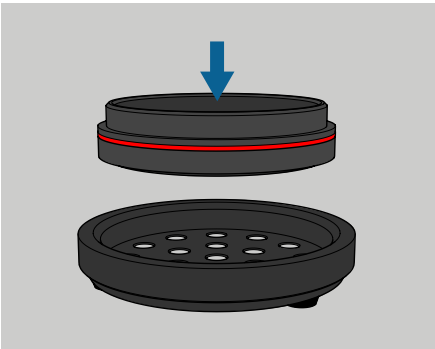

Put the red marked (smaller) part of the adapter with the marking line downward on the saturation plate, covered with a filter paper.

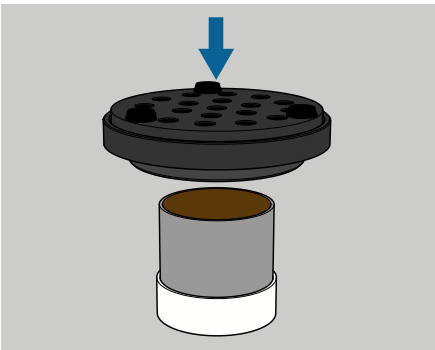

Flip the adapter and place it on top of the soil sampling ring.

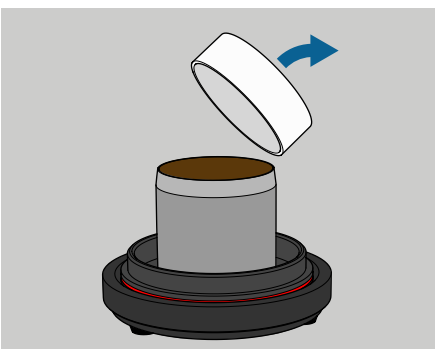

Turn the soil sample and remove the other lid.

SATURATING THE SOIL SAMPLE FOR HYPROP® MEASUREMENTS

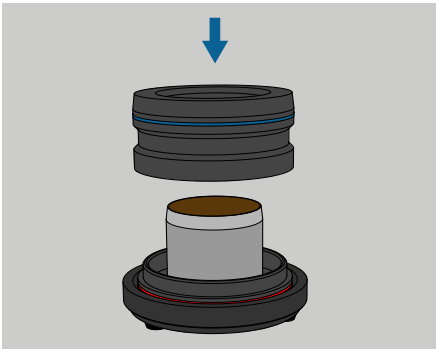

Put the blue marked (bigger) part of the adapter air free with the marking line upwards on top of the soil sampling ring.

Put the sample in a water pan.

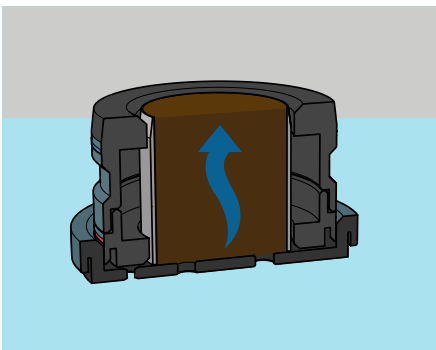

Fill the pan with water until it is just below the top of the sample ring (recommended times see below). Carefully tilt the sample including the saturation plate to let escape air bubbles.

Do not pour water on the sample – you may trap air.

TYPICAL SATURATING TIMES

| Material | fill up after | saturated after |
|-------------|----------------|-----------------|
| coarse sand | approx. 9 min | approx. 10 min |
| fine sand | approx. 45 min | approx. 1 hrs |
| silt | approx. 6 hrs | approx. 24 hrs |
| clay | n.a. | up to 2 weeks |

2.2

MOUNTING THE SAMPLE FOR HYPROP[®] MEASUREMENTS

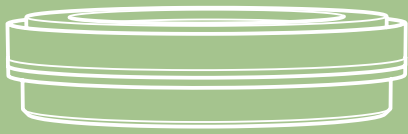

lower 2" adapter

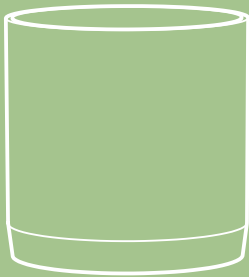

2" sampling ring

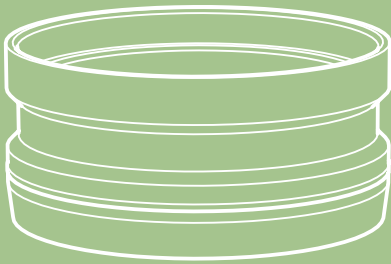

upper 2" adapter

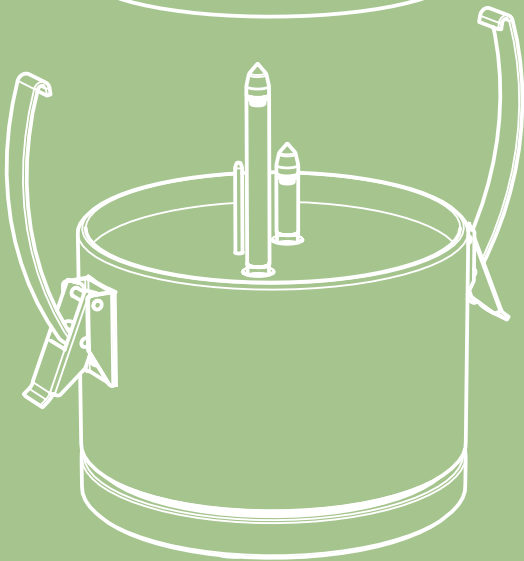

MOUNTING THE SAMPLE FOR HYPROP® MEASUREMENTS

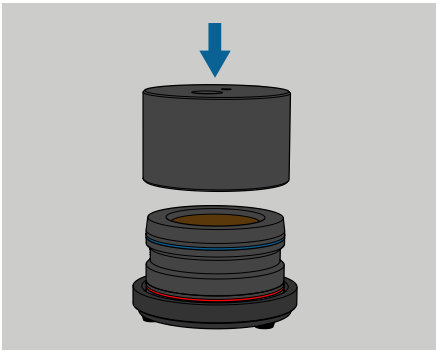

When the saturation is done take the soil sample out of the water pan and put the auger guide on top of the blue marked part of the adapter for augering the holes for the tensiometer shafts.

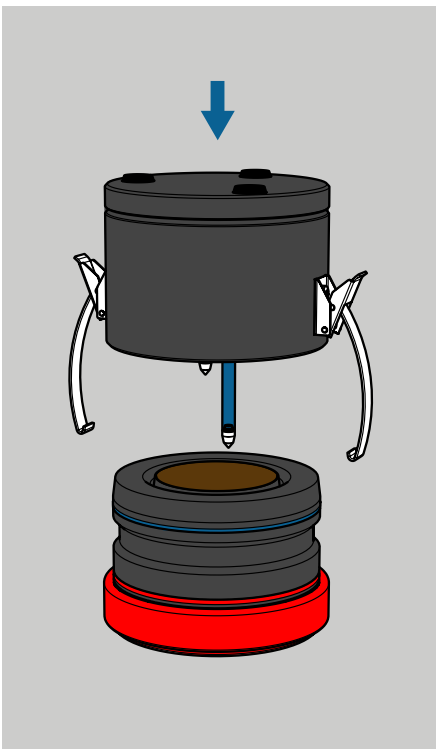

Put the refilled HYPROP® (for instructions about the preparation of the HYPROP® please read the HYPROP® manual) on top of the soil sample, turn the system upside down, remove the saturation plate and close the HYPROP® clips. Cover the soil sample with a lid to prevent evaporation before start of measurement.

For evaluation with HYPROP FIT please insert the adapter's net weight into the flag „information“, „weight correction“.

MOUNTING THE SAMPLE FOR HYPROP[®] MEASUREMENTS

3.

ACCESSORIES

ACCESSORIES

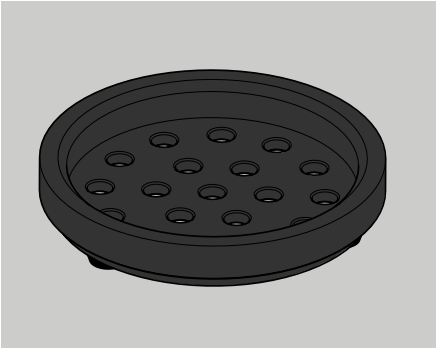

Saturation Plate

Order Code: 020253

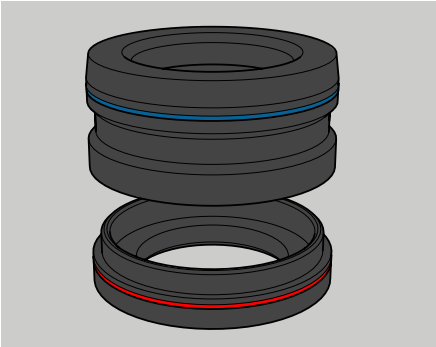

2"-adapter

Order Code: 0201560

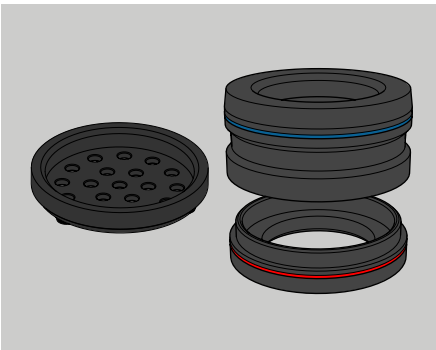

Set (Saturation Plate & 2"-adapter)

Order Code: 020150

