

**A Thermal Dissipation Sap Velocity Probe
for Measurement of Sap Flow in Plants
August 22, 1997
Dynamax, Inc.**

1. Introduction

The transpiration rate of whole plants is closely approximated by the sap flow rate in the main stem or trunk. This quantity, expressed in g/h or similar units, can be measured and recorded *in situ* and non-invasively with Dynamax stem gages, which are wrapped around the stem or trunk. When the trunk diameter exceeds 50 mm (2 inches), the gages become larger and more complex. For trunks larger than 125 mm (5 inches), using stem gages is not practical. Also, each Dynamax trunk gage from 50 mm to 100 mm has 16 T-C junctions differentially arranged in four separate measurement locations around the trunk, making them more costly.

For these reasons there is a need for a relatively simple and affordable device to continuously monitor the sap flow rate in trees of all sizes. A method for that purpose was proposed by Granier (1), who inserted a needle, containing an electric heater, in the sapwood of a trunk and measured the difference between the temperature of the heated needle and that of the sapwood some distance below the needle. The method is relatively simple and it can be automated with a digital data logger. Now, the apparatus is commercially available in a fully packaged form, ready to use. In the following, Dynamax describes a new product that meets the above needs, and provides instructions for its use.

2. Explanation of the Method and Principles

The Thermal Dissipation Probe (TDP) heated needle is an improved heat dissipation sensor, as proposed by Granier, which measures the temperature of a line heat source implanted in the sapwood of a tree, referenced to the sapwood temperature at a location well below the heated needle. The probe measures the sapwood heat dissipation, which increases with sap flow and the resultant cooling of the heat source, as the apparent thermal conductance of sapwood increases with sap velocity. When the sap flow velocity is zero or minimal, the temperature difference (dT) between the two sensors is maximal. When the flow increases, this temperature difference decreases. This approach enables the measurement of sap flow velocity with inexpensive equipment from a known relation between dT and the sap velocity.

An important feature of the Thermal Dissipation Probe (TDP) is that a constant heat method is used, that is, the heating element of the probe stays on and permits continuous and frequent measurements. This is in contrast to the so-called heat pulse method, or the Heat Pulse Velocity method (HPV), in which the sap velocity is found from the time lag between pulses and the distance between sensors. In heat pulse systems time and distance are critical, whereas in the Thermal Dissipation Probe (TDP) method, neither time nor distance are critical. In addition, the HPV method requires a waiting period between readings, whereas with the TDP method the signals are continuously available to the logger. In the Dynamax TDP method, the difference in temperature between the probes, dT , is recorded and automatically converted to sap velocity.

Granier defined a dimensionless "flow index" (K), calculated from the measured temperature difference and the maximum value thereof, occurring at zero flow velocity. He then established an empirical relation between the value of K and the actual sap flow velocity, measured in m/s, using trunk sections of 40 - 50 mm diameter. This exponential relation did not differ significantly between a number of common tree species.

Revised: September-2016

Since the TDP method gives a continuous record of sap flow velocity, it also records the sap flow rate, as the product of the former with the sapwood area. This area must be determined for each tree specimen on which measurements are made. Clearly, this produces an estimate of the sap flow rate, but one that may be sufficiently close for many purposes. To determine the sap flow rate more accurately the multiplier must be found from an empirical calibration of each trunk under study. In this respect, the TDP method does not differ from the heat pulse method. The Dynagage heat balance sensors, on the other hand, make an absolute measurement of the sap flow rate, requiring no calibration or the measurement of a "flow index".

It should be understood that the sap flow velocity varies within the sapwood, as shown by Granier (unpublished data). Therefore, what is being measured with the TDP method is an integral of the sap flow velocity over the radial thickness of the sapwood. In addition, the actual or microscopic velocity of the sap in the xylem vessels, as measurable with dye tracers, is significantly greater than the macroscopic velocity indicated by the TDP method, since the presence of the needles averages their temperature over the entire sapwood in which they are embedded. The fact that the length of the needle and the thickness of the sapwood cannot be exactly the same, introduces some uncertainty in the calculation of the sap flow velocity, reflected in the relation between the latter and the temperature difference dT , as evident from the work by Granier (1, Figure 2).

In spite of the two sources of error cited in the two paragraphs above and the possible effects of environmental parameters on the temperature difference dT , the method produces reproducible results and reasonable agreement with independent estimates of the sap flow rate (Granier, 3).

In contrast, Dynagage heat-balance sensors make an absolute measurement of the heat carried by the sap and require no calibration or calculation of a "flow index". Dynagage trunk flow sensors can be used to calibrate the TDP sensor method. Another calibration option is to weigh the whole tree periodically, but this is often impractical or not affordable.

Figure 1 - TDP Sap Velocity Probe

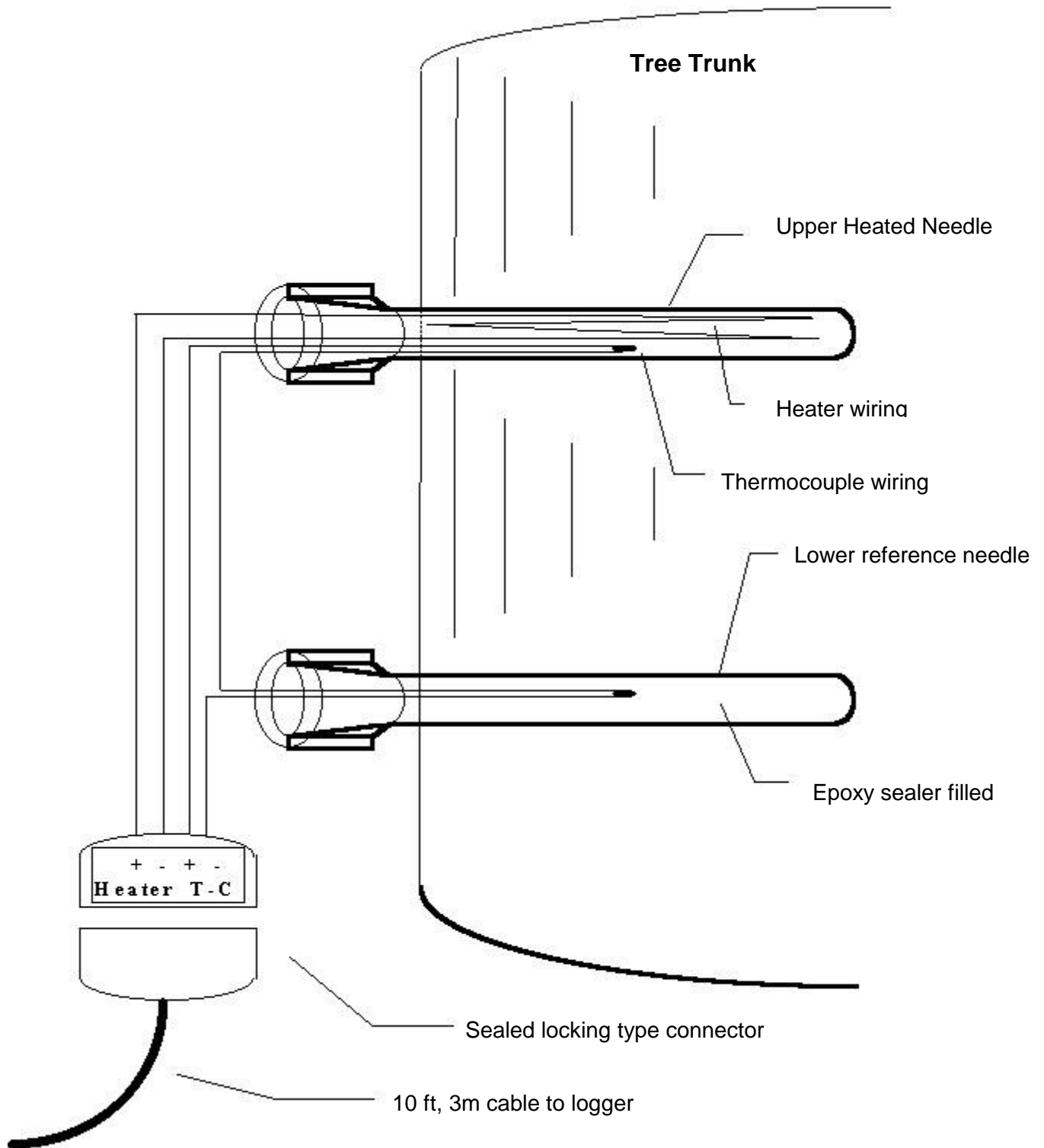

3. TDP Probe and System Description

A probe set consists of two needles, a heated needle above and a reference needle below. The heated needle has a heating element and a copper-constantan thermojunction inserted in a 1.2 mm diameter (o.d.) stainless steel tube that is 30 mm long (see Figure 1). The longer TDP-80 probes (80 mm long) are supplied with two thermojunctions in each needle to give two temperature differences across the sapwood area. The reference needle has no heating element. The probe electronics are sealed with an epoxy resin that is impervious to water.

In many tree species, the sapwood comprises the outer part of the (ring-porous) trunk to a depth of 30 to 40 mm. In some species the xylem is more dispersed throughout the trunk and the use of the 80 mm probe (TDP-80) is recommended over that of the 30 mm one (TDP-30). The TDP probe is installed into the trunk in a vertical line with the needles 40 mm apart. The heated probe is supplied with a constant electric voltage and the temperature difference between the probes is monitored. The power of the heating element is about 0.20 Watts which raises its temperature by approximately 8 to 10 C, when the velocity is at or near zero.

Because sap flow varies around the circumference of trees, more than one probe can be inserted into a single trunk to make more representative flow calculations. Dynamax recommends installing 2 probe sets per tree for trees 5" to 8" (125 to 200 mm) in diameter, and 4 probe sets per tree for trees over 8" (200 mm) in diameter. This means that our fully expanded 60-channel logger system can monitor up to 15 large or 30 small trees, using available extension cables.

4. Probe Specifications

| TDP Size | Length | Diameter | Spacing | Power | Cable/ Standard | Heater Resistance | Operation Voltage | TC Connections |
|----------|--------|----------|---------|--------------|--------------------|----------------------|----------------------|-------------------|
| TDP10 | 10 mm | 1.2 mm | 40 mm | .08 to .12 W | 10ft./5 Cond | 26 ohms | 2V | 1 T-Type |
| TDP30 | 30 mm | 1.2 mm | 40 mm | .15 to .2 W | 10ft./5 Cond | 50 ohms | 3V | 1 T-Type |
| TDP50 | 50 mm | 1.65 mm | 40 mm | .32 W | 10ft./5 Cond | 78 ohms | 5V | 1 T-Type |
| TDP80 | 80 mm | 1.65 mm | 40 mm | .5 W | 10ft./6 Cond | 110 ohms | 7.5V | 2 T-Type |
| TDP100 | 100 mm | 1.65 mm | 40 mm | .44 W | 10ft./7 Cond | 145 ohms | 8V | 3 T-Type |

Extension Cables Extension Cables are available in 25ft, 50ft and 75ft lengths. Other lengths are available. The sensor cables come with male and female sealed environment locking-type connectors for fast connection to extension cables.

5. DL2e Logger Specifications

The thermocouples of the TDP probes, when used with a Model DL2e data logger, can resolve 0.025⁰C. The DL2e data logger can have up to 4 LAC1 analog input cards, each of which can handle 15 separate probe sets, for a total of 60 probe sets. The minimum system, model FlowTP-4, includes 15 input channels and four TDP probes, leaving room for 11 additional probes. The power to the heated needle is regulated by an adjustable voltage regulator, which can handle up to 60 probes. For flexibility in adjustment of each sensor group, Dynamax recommends an adjustable voltage regulator for every four to eight probes.

DL2e Logger Specifications

- * Multi-Channel Data Logger, 1-62 Inputs
- * Weatherproof, Durable, Portable
- * Records Analog, Digital or Pulse Inputs
- * DC Volts and Resistance (4-20mV possible)
- * 2,3, or 4 Wire Connections and Differential Voltages
- * Resolution to 1uV
- * Memory will hold up to 128,000 readings with expansion cards
- * RS232 Interface to PC
- * Software for Configuration and Data Analysis
- * Comes with (1)LAC1 15/30 Input Card and enough memory for 32,000 readings.
- * Additional temperature, soil moisture and meteorology measurements may be added.

6. Software Programming and Calculations

The Granier method is based on liquid velocity heat dissipation theory, and not a specific model of heat transport in plant stems or tree trunks. Similar air flow sensors and hot-wire anemometer techniques are widely used in other applications. However, the Granier method does require knowledge of the physical dimensions of the sapwood to convert velocity to sap flow rate.

Granier (1,2) defined a dimensional parameter K as:

$$K = (dT_M - dT) / dT$$

dT is the measured difference in temperature between that of the heated needle, referenced to the lower non-heated needle, placed at a fixed distance below the heated one. The value of dT is found from the differential voltage measured between the upper and lower thermocouple. The parameter dT_M is the value of dT when there is no sap flow (zero set value). Clearly, when dT = 0, K equals infinity and, if dT = dT_M, K = 0 (zero flow).

Granier found empirically that the average sap flow velocity V (cm/s) could be related to K by an exponential expression:

$$V = 0.0119 * K^{1.231} \quad \text{cm/s}$$

To convert the velocity to sap flow rate, one uses:

$$F_S = A_S * V * 3600 \text{ (s/h)} \quad \text{cm}^3/\text{h}$$

where F_S (cm³/h) is the sap flow (cm³/h), and A_S is the cross-sectional area of sap conducting wood (cm²). Typical midday values for V are from 10 to 80 cm/h, as reported by Granier (1,3).

PC software, based on the above expressions and standard thermocouple tables, is provided. It calculates the temperature difference and converts the latter into sap velocity. The software provided with the DL2 datalogger collects and transfers data to a spreadsheet program which calculates the sap flow rates (IBM compatible software). This software also allows for easy plotting and graphing of data files.

References:

- 1) Granier, A. (1985). Une nouvelle methode pour la mesure du flux de sève brute dans le tronc des arbres. *Ann. Sci. For.*, 42:81-88.
- 2) Granier, A. (1987). Evaluation of transpiration in a Douglas fir stand by means of sap flow measurements. *Tree Physiology*, 3:309-320.
- 3) Granier, A., R. Huc and S.T. Barigali (1996). Transpiration of natural rain forest and its dependence on climatic factors. *Agricultural and Forest Meteorology* 78:19-29.

DL2e Specifications Logging

| | |
|-------------------------|--|
| LOGGING INTERVAL | 1, 5, 10, 30 seconds, 1, 5, 10, 30 minutes, or 1, 2, 4, 12, or 24 hours, programmable for each channel. |
| AND SPEED | Readings can also be reduced to averages, maxima or minima at these intervals. Typically 10 channels per second total. |
| INPUT CHANNELS | 60 channels maximum, depending on input cards installed, plus resident digital inputs. And 2 relay outputs. |

Analogue Inputs

| | |
|-------------------------------------|--|
| STANDARD ANALOGUE CARD, LAC1 | Each LAC1 multiplexer card can select analogue inputs from: Either: 15 channels of differential voltages and/or 3-wire resistances. Or: 30 channels of single-ended (common ground) voltages and/or 2-wire resistances. Directly measure voltages up to $\pm 2V$ or resistances $< 1M\Omega$. Voltages up to $\pm 50V$ can be measured using Precision divider or shunt resistors mounted directly on the input screw terminals, or on an LPR1 or LPR1V card. |
| 4-WIRE CARD, LFW1 | Each LFW1 card can handle up to 12 bridge, potentiometric, differential voltage or 2 or 4-wire resistance sensors. 4-wire resistance measurements virtually eliminate cable resistance errors. 4-wire Pt100 platinum resistance Thermometers, (e.g. DIN 43760/BS1904 types) are measured over -200 to $+850^{\circ}C$. In the -17 to $+57^{\circ}C$ Range of Logger and Pt100 temperature, resolution of $0.01^{\circ}C$ and accuracy of $\pm 0.2^{\circ}C$ are obtained. |
| AC/DC INPUT CARD, ACD1 | Each ACD1 card provides 15 measurement channels which may be individually configured for AC voltage (true rms), DC voltage (differential), 2 or 3-wire resistance. DC and resistance specifications are the same for LAC1 |

| | | | |
|-------------------------|--|---|---|
| VOLTAGE READINGS | 4 ranges, user selected Or auto ranged: | Full Scale Range 1: $\pm 4mV$ Range 2: $\pm 32mV$ Range 3: $\pm 262mV$ Range 4: $\pm 2.097V$ | Resolution (12bits + sign) $1\mu V$ $8\mu V$ $64\mu V$ $0.5mV$ |
|-------------------------|--|---|---|

| | | | |
|---|---|---|---|
| DC ACCURACY (typical figures in brackets) | Logger temperature Full-scale error Long term stability Differential offset Noise Input impedance Common Mode Range Common Mode Rejection Ratio | 15 to 25°C $\pm 0.07\%$ (0.04%) $\pm 0.25\%$ (0.02%) over 1 year $\pm 10\mu V$ ($3\mu V$) $\pm 0.02\%$ ($0.2\mu V$ rms) 100 $M\Omega$ approx. $\pm 2V$ or $\pm 1.5V$ if "+" input is closer to logger OV than "-" input (140dB) on voltage range 1 | -20 to +60°C $\pm 0.2\%$ (0.1%) $\pm 12\mu V$ $\pm 0.02\%$ |
|---|---|---|---|

| | | | | |
|--------------------|---|---|---|--|
| AC ACCURACY | Input Level (mV ac rms) 0 to 10 10 to 50 $\pm 3mV$ 50 to 100 100 to 200 | Sinusoidal signals 45-60 Hz, -20 to $+60^{\circ}C$ Reads zero in this range $\pm 6\%$ reading $\pm 0.25MV$ ± 6 reading | Sinusoidal signals 65-1000 Hz Reads zero in this range $\pm 6\%$ reading error $\pm 1.0\%$ reading | Non-sinusoidal signals Crest Factor 1.0 to 1.7 Reads zero in this range maximum additional |
|--------------------|---|---|---|--|

| | |
|----------------------------|---|
| RESISTANCE READINGS | Auto-ranging 12-bit voltage reading with programmable 2, 20, 20, 200 or 2000 μA excitation, giving 1 $M\Omega$ full scale, or better than 0.01 Ω resolution on lowest range. |
|----------------------------|---|

| | | | |
|-------------------------|---|--|--|
| ACCURACY | As voltage readings, with additional errors: Logger temperature 2 μ A excitation other excitation currents 2-wire LAC1, ACD1 | 15 to 25°C $\pm 0.3\%$ reading $\pm 0.5\%$ reading $\pm 5\Omega$ typical | -20 to +60°C $\pm 0.6\%$ reading (to 50°C) $\pm 0.1\%$ reading $\pm 5\Omega$ typical |
| INPUT PROTECTION | Analogue inputs withstand $\pm 15V$ continuously, and much higher voltages in brief pulses (500V 1.2/50 μ s). For additional protection, see LPR1V below. | | |
| ATTENUATOR | For use with Standard Analogue card LAC1 only provides socketed positions for mounting signal conditioning resistors to 30 channels. Resistors may be left vacant or resistors fitted in shunt or divider Configuration, for measuring currents up to 0.1A or voltages up to +/-50V respectively. | | |
| CARD, LPR1 | | | |

Digital Inputs and Outputs

| | |
|---------------------------|---|
| DIGITAL INPUTS | All loggers have 2 resident 16-bit counter channels that continuously monitor logic levels or switch closures, logging digital status, counts or frequency (up to 100Hz), or for triggering special logging sequences. |
| COUNTER CARD, DLC1 | Each DLC1 card provides up to 15 extra 16-bit counter or frequency channels. Maximum frequency: 500 Hz for switch closures, 500kHz for 5V logic level signals. Every channel can record up to 65472 counts over the logging interval. |
| RELAY OUTPUTS | 2 SPDT relays for powering up sensors, or for providing alarms or malfunction warnings. 1A, 24V rating. |

Other Specifications

| | |
|-----------------------------------|---|
| PROCESSING OF RAW READINGS | The DL2e converts readings into engineering units using look-up tables or a linear conversion $y = mx + c$. User expandable sensor library includes Delta-T sensors (pages 15-18), Platinum Resistance Thermometers, Thermistors (Fenwal 2K, 2K252, 10K and 100K types), and Thermocouples (types J, K, and T). Cold junction temperature is measured at isothermal terminals. |
| DISPLAY | A 2-line LCD shows instantaneous output from any sensor (in engineering units if appropriate), time, battery and memory condition and status messages, without disturbing logging. |
| MEMORY | Highly reliable CMOS RAM, double battery-backed. Expandable from 64K readings (standard) to 128k. |
| DATA FORMAT | Automatic RAM check. ASCII, easily loaded into many spreadsheets and other packages, e.g. Excel, Lotus 1-2-3. Transmitted Readings are date/time stamped, and labeled in engineering units with errors flagged. Data files created by the LS2e software is comma separated. |
| INTERFACE | RS-232 Serial, up to 9600 baud. Up to 10000 readings transferred per minute without disturbing logging. |
| POWER | 6 internal AA alkaline cells typically provide power for 500K readings, or 24 hours' operation using the keypad/LCD Or RS232 interface, or 12 months' quiescent operation. An external 7-15V DC supply can be used, with the alkaline batteries providing a back-up. The internal lithium cell will retain data for 2 months in the event of a power supply failure. |
| ENVIRONMENTAL | Operating temperature: -20 to +60°C. IP65 weather proof main case with desiccant and humidity Indicator. |
| EMC CONFORMITY | Tested to comply with EN 50081-1 and EN-50082-1 (1992) harmonized emissions and immunity standards |
| SIZE / WEIGHT | 280 x 220 x 140mm / 2.7 kg. |

7. Probe Installation

A. Preparation of Probe Site

Once sample trees are selected, an installation site is prepared on the surface of the trees. This is done by shaving off the corky bark and clearing room for a rectangular area roughly 4 cm wide and 10 cm tall. Only the outer bark of the plant is removed and damage to living tissues should be avoided. The site should be 1 to 2 meters above the ground to prevent thermal gradients created by cool sap as it emerges from the soil.

CAUTION

We recommend extra precaution be used for trees of value. The drill bits should be rinsed in 10% Clorox (chlorine bleach) solution before drilling. One should re-rinse between trees to prevent spread of disease from tree to tree.

Place the drilling jig flat on the prepared surface and drill pilot holes 30 mm deep using the small drill bit supplied, 0.055" diameter (size #54 depending on the TDP sizes ordered), and a suitable drill. Two drill bit sizes are provided. The smaller diameter drill bit is only 0.002" larger than the needles, and should be used first. Most trees, especially hardwoods, will not swell up inside the hole and this will be the drill bit most often used.

The larger drill bits, 0.070" (size #50 depending on the TDP sizes ordered) are provided for softwoods, or other trees that may swell up the fibers inside the hole, preventing a smooth needle insertion. Be extremely careful that no force to insert the needle causes it to buckle, since this will cause it to crack and most likely break upon removal. If the sensor needles do not push in smoothly and are binding in the holes, carefully pry the needles out (see removal section) and then drill the hole out to the larger diameter, without using the drill jig.

| | | |
|--|------------------|---------------------------|
| For TDP50 - TDP100, drill bit sizes will be: | .070" (size #50) | larger bit, softwood tree |
| | .073" (size #49) | pilot hole, hardwood tree |

Holes will be drilled for length of probes:
TDP10 - 10mm deep
TDP30 - 30mm deep
TDP50 - 50mm deep
TDP80 - 80mm deep
TDP100 - 100mm deep

A lightweight portable drill is handy for drilling holes in the field. The holes are 40 mm apart but this is not critical, as long as they are in a close vertical line. Remove any loose particles by reversing the drill and running the bit in and out of the hole a few times. Stop drilling and clean the bit if particles are wedged into the drill flutes.

Remove the drilling jig and use a syringe to rinse the installation site with hydrogen peroxide. A syringe with a 20-gage needle is supplied to flush the drill holes. This is to minimize the introduction of pathogens into the plant and to promote a quick healing response in the drilled holes. We recommend extra precaution be used for trees of value, so the drill bit should be rinsed in 10% Clorox (chlorine bleach) solution before drilling. One should re-rinse the drill bits between trees to prevent spread of disease from tree to tree.

A single probe may be used on trees 3-5" (to 125 mm) in diameter, but two or more probes are

recommended for trees in the 5-8" (to 200 mm) diameter range. Very large trees, over 8" (200 mm) may require four or more. In closed canopies, where trees are more uniform in size and spacing, good results are reported with just one probe per tree, regardless of size. This recommendation is based on past experience (Granier, 1987) but is strongly influenced by the objectives of the study and on the plant species being tested.

Ambient temperature gradients can be reduced significantly by wrapping an insulating jacket of flexible porous foam at least 5 cm (2") thick and twice as long as the tree diameter around the trunk, centered on the midpoint between the two needles.

B. Installing the TDP Probes

Use care when handling the sensor wires, especially the constantan wire (inside a protective tube connecting both probes for differential temperature). The wires are thin and are damaged beyond repair if broken.

Insert the TDP needles with the heated needle (four wires including red and black) in the top hole and the reference needle in the bottom hole. Insert the needles about 10 mm at a time, pushing each needle alternately until almost all the way in, leaving 2-3 mm of shaft still visible. This leaves room for the tree to add bark growth and not damage the TDP needle. Also, be careful not to damage the wire that is common to both probes during this process. The insulation around the probe wires make them appear larger than they really are but these are actually very fine wires. Do not stress or pull the wires at the probe connections.

CAUTION

Do not bend or twist the probes to insert them. A bend in the probe will cause internal breakage.

Once the probes are in place the cables must be tied or taped to the tree for support and to remove stress from the probes. Duct tape or twine is useful for this purpose.

C. Thermal and Rain Insulation

Install plastic putty or pruning wax sealer around the needles, to surround them with a waterproofing seal. This will prevent water from touching the needle shaft, and causing a heat sink effect. Install foam quarter-spheres (or foam quarter eggs) on either side of the TDP needles to protect the sensor wiring from bending stresses, and to add thermal insulation around the needles. Tape these foam blocks to the tree.

Reflective bubble wrap or insulation is now wrapped around the tree, the foam blocks and the TDP probe installation. The reflective bubble shield may only be enough to form a tent or skirt around the tree where the measurements are taken. More shielding may be necessary to prevent the sun from shining on or below the area being measured. The sun can cause large local gradients on the stem, which can add or subtract from the temperature changes due to sap velocity. This wrap is also secured by reflective tape or twine. Securely sealing the top of the wrapping will certainly be prudent for preventing water running down the stem and touching the sensors.

Attach the TDP cables to the extension cables of the logger and the installation is complete. Ground the data logger to a heavy gauge copper rod buried at least four feet into the ground.

D. Probe Removal

| |
|----------------|
| CAUTION |
|----------------|

When removing the probes, do not pull out by the base of the needle by hand or by pliers. A nail removing pry-bar (a short, 30-40 cm long pry bar is sufficient) lever should be addressed to the base of the needle, where the needle shaft (cannula) meets the hub, so that they can easily be withdrawn about 3-5 mm with a moderate force.

We recommend a short lever, and not a claw hammer, because hammers will easily bend these needles. After loosening each needle in the set, withdraw the needles by adding a 5 mm (1/8" to 1/4") wooden fulcrum between the tree and the pry bar. With a moderate (1 to 5 lb.) force withdraw each needle an additional 5 mm, then increase the thickness of the fulcrum another 5 mm. The lever should only have contact with the smaller section of the hub. Attempting extraction by pulling at the shaft of the needle may cause damage.

Continue this process, adding a thicker fulcrum, so that the pulling force is always perpendicular to the tree, in a straight line with the needle. This process will avoid any bending moments on the needle itself. By pulling each needle in turn, it is possible to remove each needle in the set without stretching the wires entering the hub of the needle.

APPENDIX

- Page 13** Radial variation of Sap Flow within Scots Pine and Oak stems
- Page 14** Variation of sap flux density according to the depth in a beech (radius 15cm), during two bright days
- Page 15** TDP signal chart – comparison of Granier and Dynamax sap flow meters – data from TDPEXPL.XLS software example disk.
- Page 16-17** Sap flow comparison TDP & Granier probes on 15-year-old Douglas Fir – data from TDPEXMPL.XLS software example disk
- Page 18-23** Diagrams and schematics

Pinus sylvestris
1992 - day 159

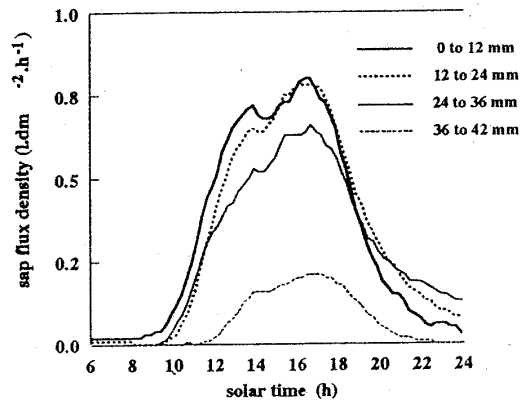

Quercus petraea
1990 - day 203

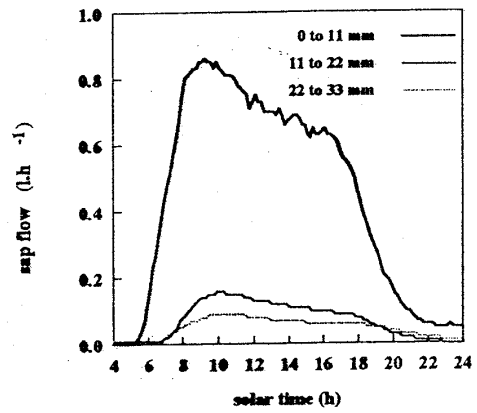

Radial variation of sap flow within Scots pine and Oak stems

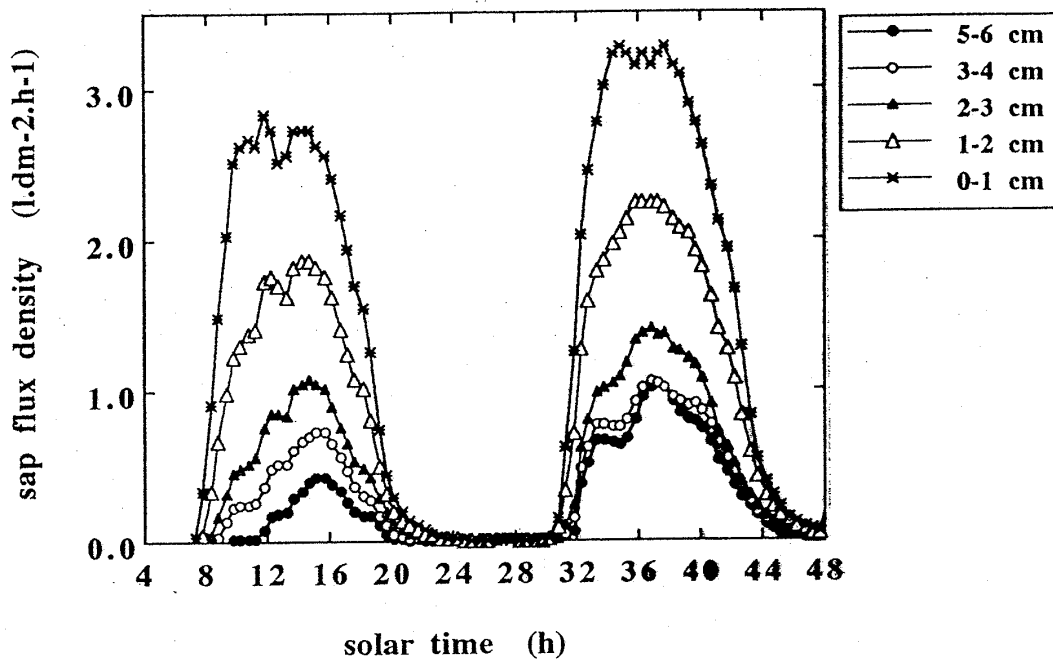

Variation of sap flux density according to the depth in a beech (radius 15 cm), during two bright days.

TDP Signal Chart

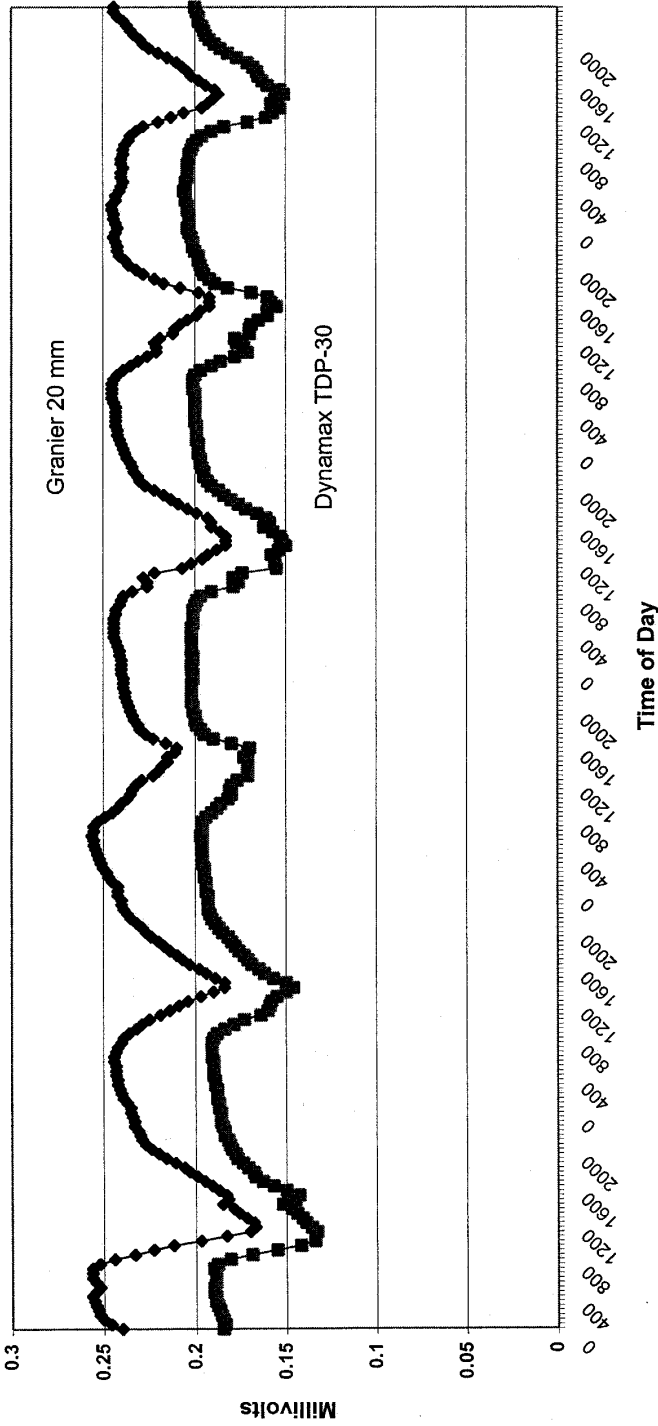

Comparison of Granier and Dynamax Sapflow meters.
DOY254-259, A. Granier, 1996
TDP-30 @65 ma / Granier @ 120 ma.
Data Courtesy of INRA

Sap Flow Comparison TDP & Granier Probes
15 Year old Douglas Fir
Data expressed as sap flux density

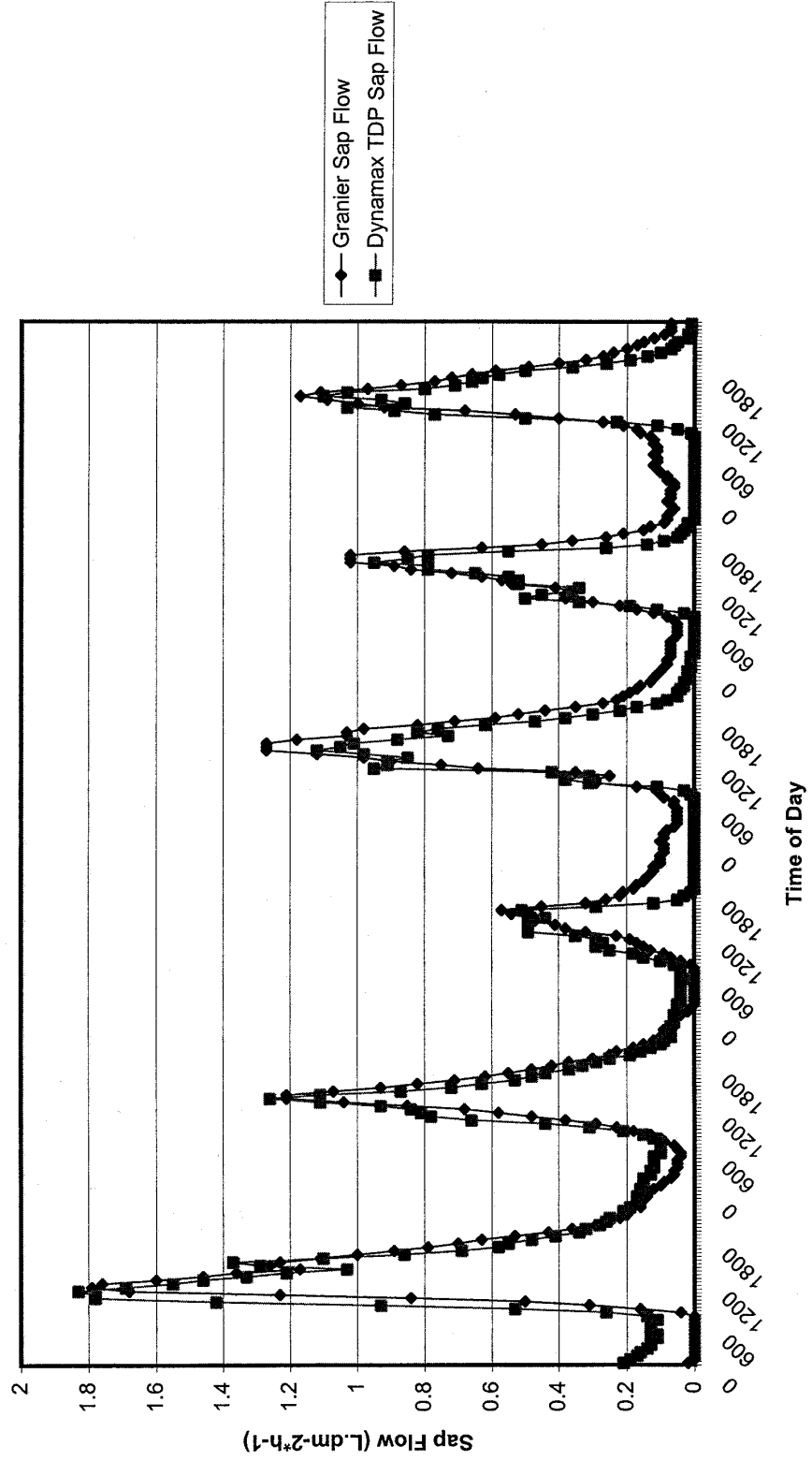

$$y = 0.964x - 0.008 \quad r^2 = 0.951$$

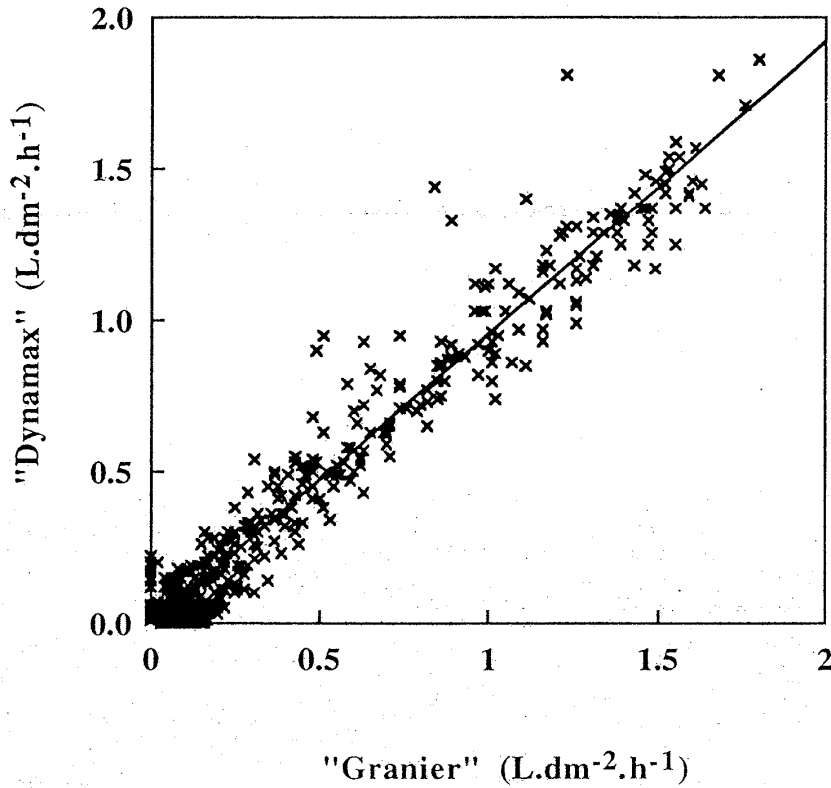

Comparison of Granier and Dynamax sapflowmeters on a 15 year-old Douglas-fir. Data are expressed in sap flux density ($\text{L.dm}^{-2}.\text{h}^{-1}$). 1996, DOY 253 to 264

TDP10

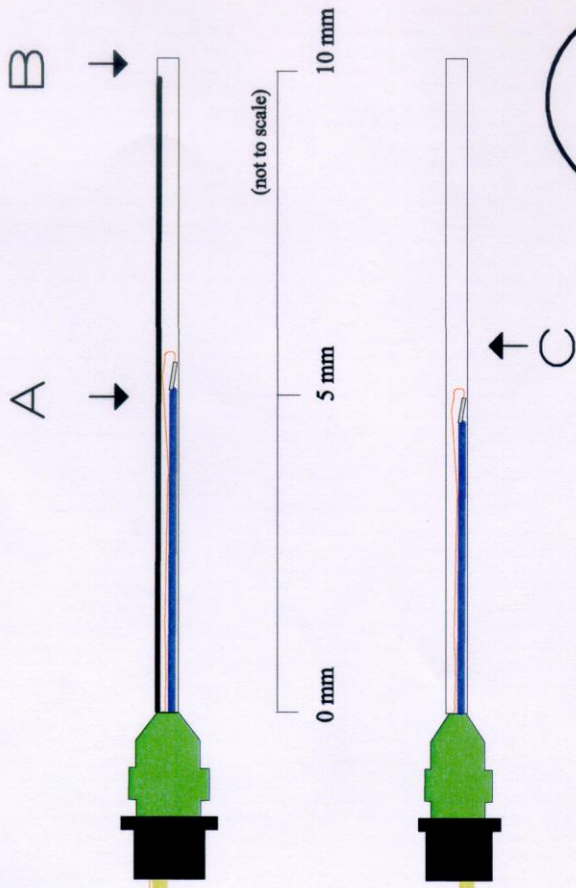

- A - Thermocouple #1
- B - Heater
- C - Reference Thermocouple

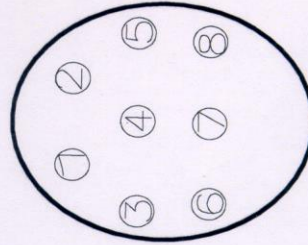

Circular Amp

- PIN #1 WHITE - DIFF VOLT (+)
- PIN #2 GREEN - DIFF VOLT (-)
- PIN #3 RED - HEATER (+)
- PIN #4 BLACK - HEATER (-)
- PIN #5 SHIELD - DATALOGGER

TDP 30

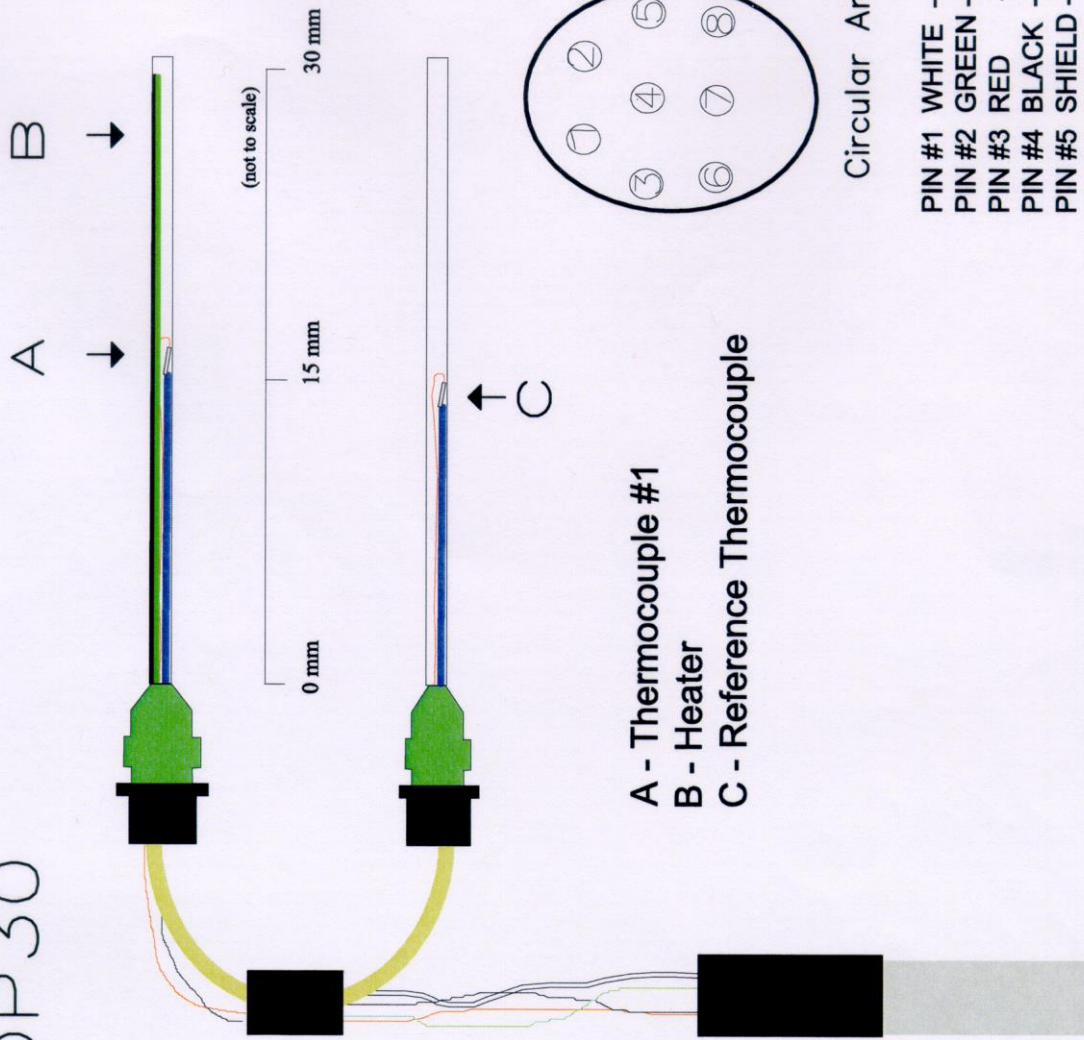

TDP50

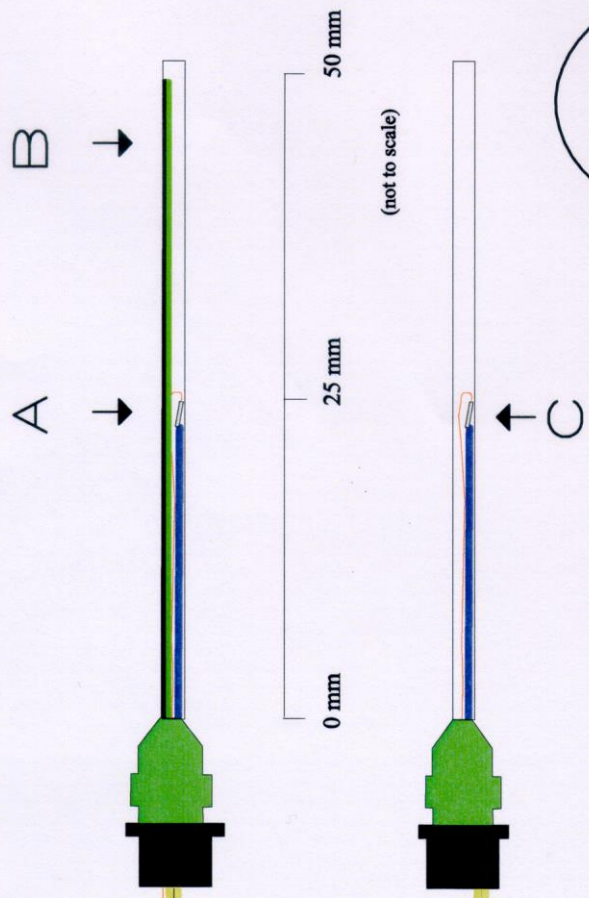

- A - Thermocouple #1
- B - Heater
- C - Reference Thermocouple

Circular Amp

- PIN #1 WHITE - DIFF VOLT (+)
- PIN #2 GREEN - DIFF VOLT (-)
- PIN #3 RED - HEATER (+)
- PIN #4 BLACK - HEATER (-)
- PIN #5 SHIELD - DATALOGGER

TDP80

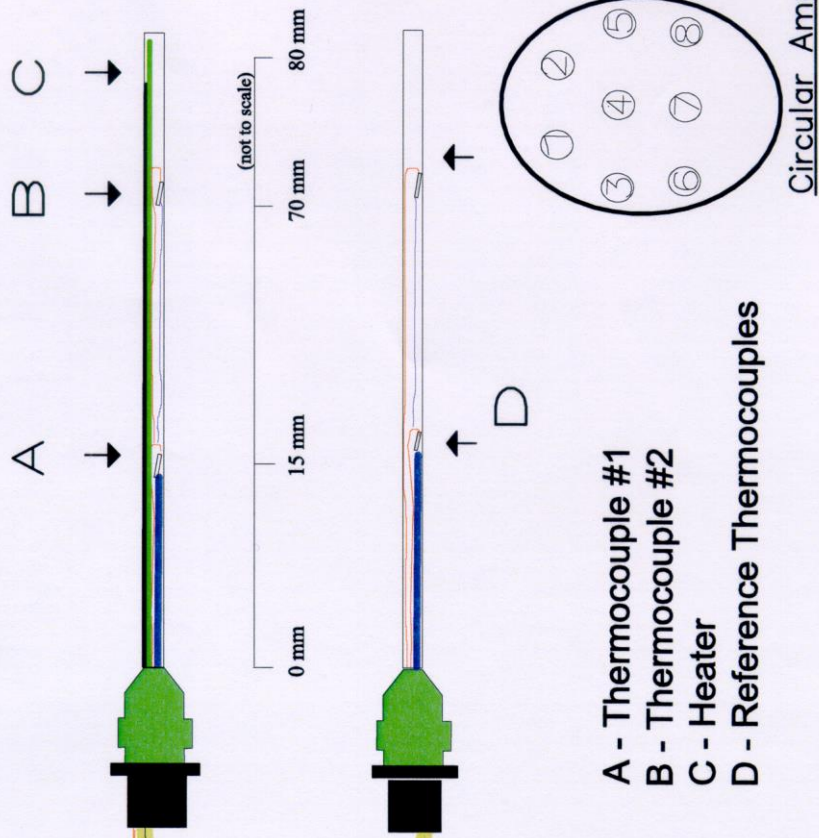

- A - Thermocouple #1
- B - Thermocouple #2
- C - Heater
- D - Reference Thermocouples

- PIN #1 WHITE - DIFF VOLT (+)
- PIN #2 GREEN - DIFF VOLT (-)
- PIN #3 RED - HEATER (+)
- PIN #4 BLACK - HEATER (-)
- PIN #5 SHIELD - DATALOGGER
- PIN #6 BROWN - DIFF VOLT (+)

TDP100

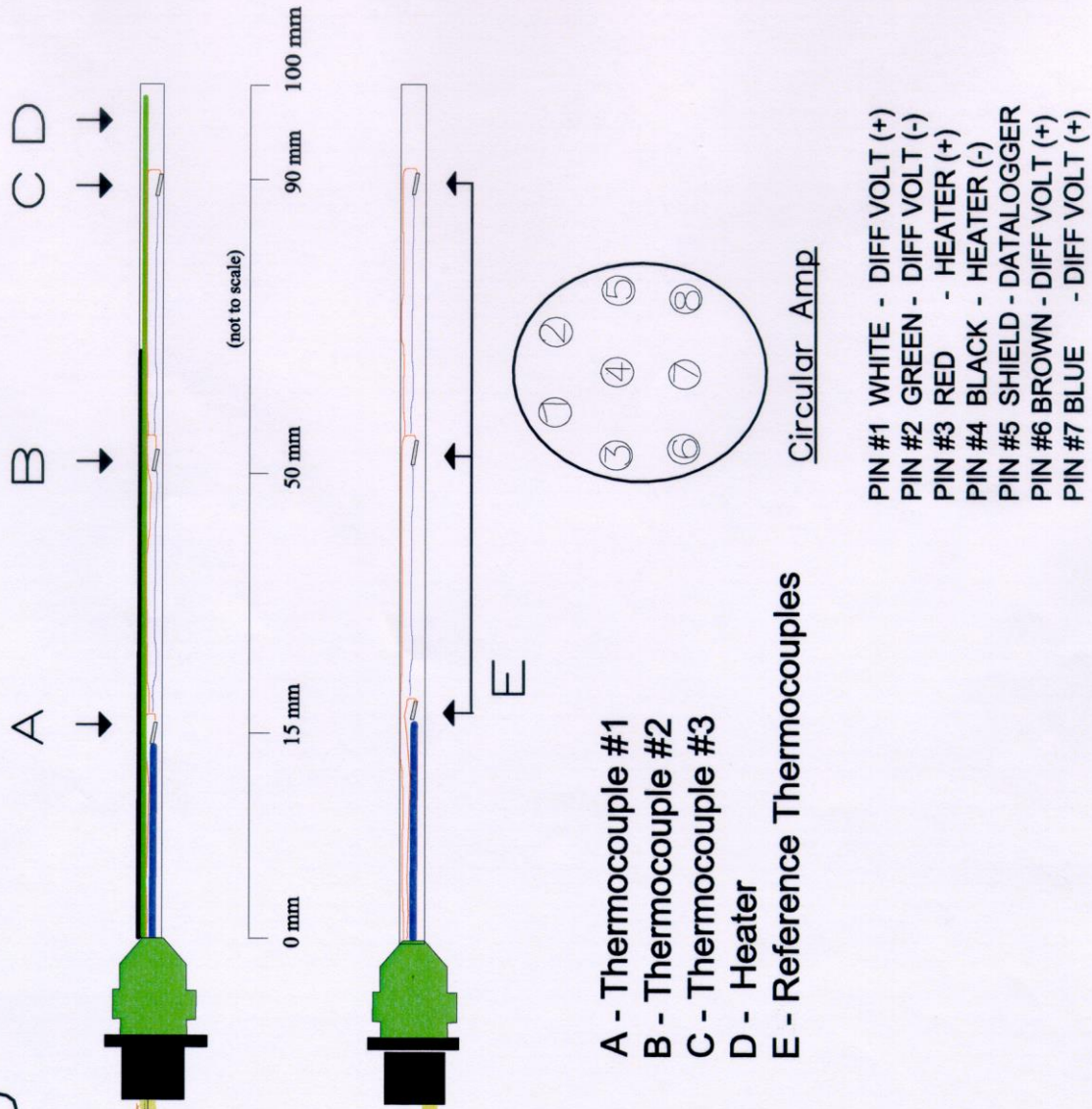

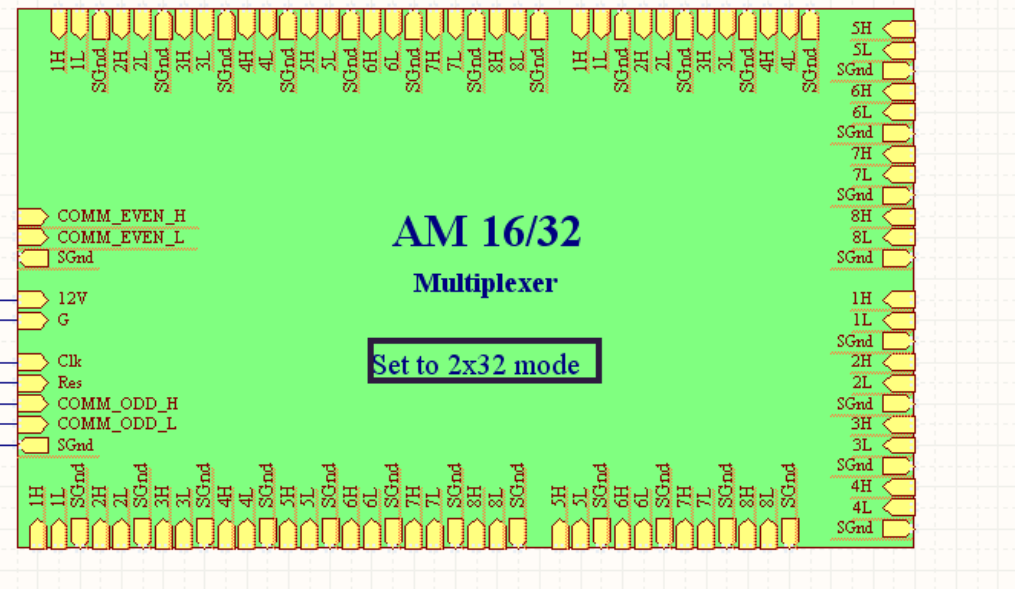
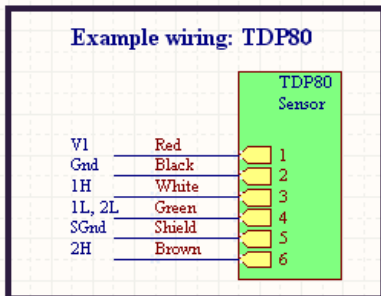
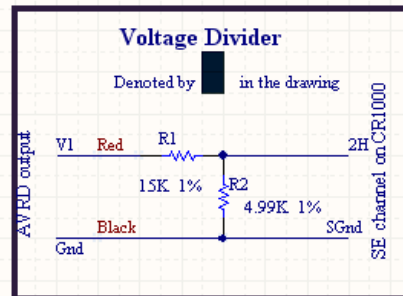
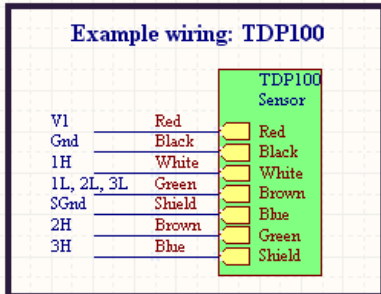
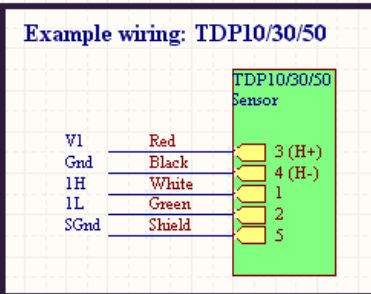
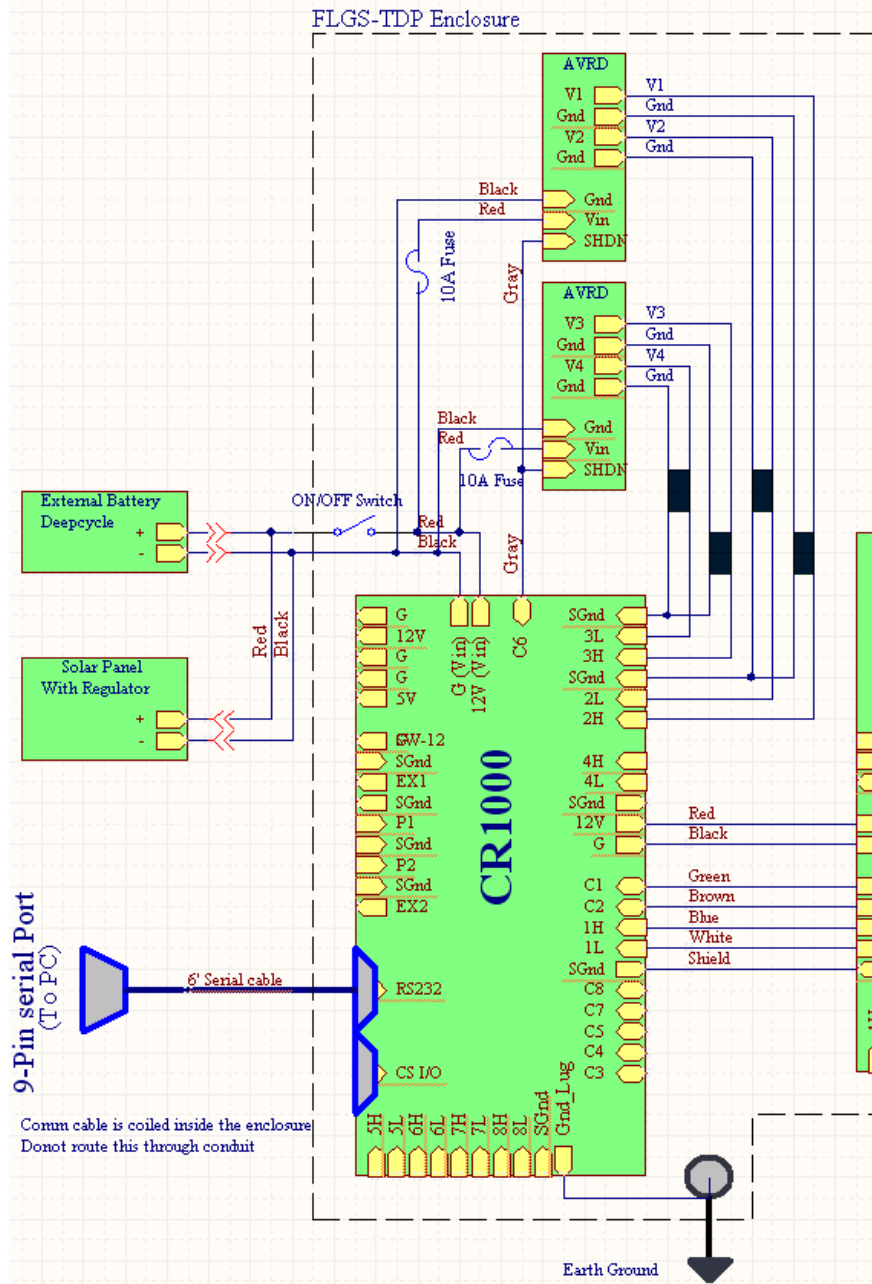

| | | |
|-------|---------------------------------------|---|
| Title | FLGS-TDP Panel & Sensor Wiring | Dynamax Inc, 10808 Fallstone Rd., Ste. 350 Houston, TX 77099, USA |
| Size | Number 1 | Revision 1.1 |
| Date: | 8/30/2006 | Sheet of 1 |
| File: | D:\D.Design\1.FLGS-TDP_Wiring3.SchDoc | Drawn By: Sai Gunguntla |