

High Conductance Flow Meter Installation and Operations Manual



Dynamax

10808 Fallstone Rd Suite 350
Houston, TX 77099 USA
Toll Free: 1-800-896-7108
Phone: 281-564-5100 FAX: 281-564-5200

E-mail: admin@dynamax.com
International Email: exports@dynamax.com
Website: www.dynamax.com

Table of Contents

1.0 Features and What is New in HCFM3.....	4-6
1.1 High Conductance Flow Meter (HCFM) Form & Function.....	7-8
1.2 Personal Computer Requirements	8
1.3 Pressured Bottle Requirements.....	8
1.4 Unpacking.....	9
1.5 What to Keep!.....	9
2.0 Quick Start Guide.....	10
3.0 Application and Theory of Operation.....	11-13
3.1 Why use the HCFM?.....	11
3.2 Transient Measurements of Conductance of Roots.....	11-13
3.3 Quasi-steady State Measurement of Hydraulic Resistance, RQS.....	13
4.0 HCFM Installation Guide.....	14-26
5.0 Setup for the HCFM.....	27-38
5.1 Operational Imperative.....	27
5.2 Valve Setting for Preparing the HCFM for Service.....	27
5.3 Pressurizing the HCFM.....	27
5.3.1 Tips for Setting the Pressure Regulator.....	28
5.3.2 Preparing the Compressed Air Supply System for use with HCFM.....	29
5.4 Adding Degassed Water to the HCFM.....	30
5.4.1 Making Degassed Water/ Preventing Algae Buildup Inside the HCFM.....	31
5.4.2 Priming a Totally Empty Captive Air Tank (CAT).....	32-33
5.4.3 Adding water to a Partly Empty Captive Air Tank (CAT).....	33-34
5.5 Elimination Air from the HCFM.....	34-35
5.5.1 Purging Air from the Water Filter.....	35-36
5.5.2 Removing Air Trapped in the 8-way Manifold.....	36
5.5.3 Removing Microscopic Air Bubbles from the Pressure Transducers.....	37
5.5.4 Removing Microscopic Air Bubbles from the HCFM-Bleeding.....	37
5.6 Storing the HCFM.....	38
6.0 Software Operation.....	39-55
6.1 System Connections.....	39
6.2 HCFM Operation Guide.....	40
6.3 Set-Zero dP-Transient Conductance Preparation.....	40-41
6.4 Transient Measurement of Conductance.....	42-45
6.4.1. Measurement of the Transient.....	42
6.4.2. Regression of the Transient, Current Data.....	45
6.5 Regression of Transient, Saved Data (.trn) Files.....	46-47
6.6 Introduction QSS Quasi-Steady State.....	48-52
6.6.1. Getting Started.....	48
6.7 Graphics Operation.....	53-54

Table of Contents

7.0 Raw Data for K, and Temperature Corrections.....	55-57
7.1 Temperature Correction with Built-in Sensor.....	55
7.2 Corrections at Test Temperature.....	55
7.3 Raw Data Tables, Project Data.....	56
7.4 K25-Conductance at Standard Temperature.....	56-57
8.0 Obtaining Good Data, and Data Presentation.....	58-61
8.1 Wound Response (Plugging of Stems).....	58
8.2 Air evenly distributed in the wood of a large branch.....	58
8.3 Cautions when measuring small flows/conductance or larger resistances.....	58
8.4 Air Bubbles.....	59-61
9.0 Connecting the HCFM to the Roots and Shoots.....	62-67
10. Disconnecting the HCFM	68
10.1 Valve Settings for moving the HCFM.....	68
10.2 Disconnecting and Moving the HCFM.....	68
11. Maintaining the HCFM.....	69
11.1 Changing the Water Filter.....	69
12. Calibration of the HCFM.....	70-77
Appendix I Parts List.....	78
Appendix II Bill of Materials.....	79
Appendix III Trouble Shooting and FAQ.....	80-81
Appendix IV Reference List.....	82-83
Appendix V Glossary.....	84-87

1. Features and What is New in HCFM GEN3

Here is a new and updated HCFM product based on the Dynamax history of 15 years of producing this leading plant characterization instrument.

- New High Res Generation 3 HCFM
- Reading Sensors direct in parts per million
- NIST calibration standard feature
- Instant data regression, and auto-saver aged results
- USB powered data acquisition
- New High speed sensor conversion module
- Flow ranges increased by 50%
- Vista, XP, supported
- Windows 7 compatible
- Upgrade packages available to previous HCFM systems, with new factory calibration

The HCFM-Gen3 measures how water movement relates to the pressure differences required to draw water from the soil or through a plant.

The hydraulic conductivity relationship is a quantitative analysis for roots and stems. The measurement is performed in the field, where in-situ root system can be measured in its natural environment.

In most cases, the analysis of a sample root or shoot is completed in as little as 10 minutes. HCFM-Gen3 measures the major components of the hydraulic conductance in the soil-plant-atmosphere continuum (reference #70.) The hydraulic architecture of a whole shoot or of a single leaf can be represented by a resistance diagram similar to the electronic circuit shown. One can measure the values of the individual hydraulic resistances, then compute the pattern of water flow and water potentials in the resistance network. Each hydraulic resistance element (R) equals the pressure difference driving flow through the element divided by the resulting flow (F) (reference #82).

All data sets are saved within the Project Manager framework file structure. Transient results as well as QSS flow meter data are saved for easy viewing in with Excel, including the computed conductance, temperature and averaged results.

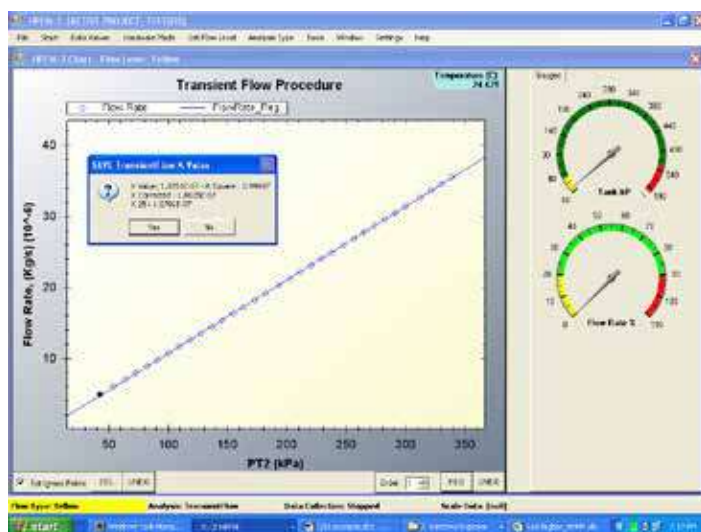

7	Index	dPaz (kPa)	Flow (kg/sec)	Cond (Kg/sec / Rest (sec MPa)	Temp (Deg C)
165	158	103.86	5.66E-07	3.49E-06	2.86E+05
166	159	103.85	5.66E-07	3.49E-06	2.86E+05
167	160	103.86	5.66E-07	3.49E-06	2.86E+05
168	161	103.84	5.66E-07	3.49E-06	2.86E+05
169	162	103.83	5.66E-07	3.49E-06	2.86E+05
170	163	103.86	5.66E-07	3.49E-06	2.86E+05
171	164	103.84	5.66E-07	3.49E-06	2.86E+05
172	AVERAGE		5.66E-07	3.49E-06	2.86E+05
173					
174					

Advantages

In the HCFM method, the resistance of the root and shoot are measured separately by pressure perfusion and added together. The HCFM will help plant physiologists and agronomists look forward to those seasonal studies of root and shoot progression, water potential, or soil treatment effects.

Designed for Two Types of Numerical Analysis

The first analysis is an in-situ transient analysis of hydraulic conductance. HCFM measures the flow as the water pressure increases while flowing into the root or shoot. The software then intelligently calculates the slope of the increased flow and pressure. That slope is the hydraulic conductance. The second analysis is a quasi-steady state flow meter, (QSS), providing a constant pressure and flow into the sample. This derives the flow pressure and conductance in a steady state environment, and computes conductance, as well as hydraulic resistance.

The complete HCFM system is field portable with detachable wheels and backpack. The HCFM-XP is a completely portable suitcase version of the HCFM-Gen3 (5 range limit).

Software

The HCFM comes with menu driven software that is easy to use and straightforward in it's approach. The software also includes diagnostics and calibration modes to assure the user of correct readings. All data is saved to the PC hard drive for later analysis by HCFM or graphing packages.

What's New

- 1000 times more resolution with a highly advanced analog processing board (24 bit A/D)
- Highest analog resolution on the market provided
- USB powered Analog to digital circuit – Batteries not required
- Single USB high-speed data stream – No more parallel port to add
- Powerful instant regressions, with chart saving and printing
- All regression and streaming data are saved automatically – No more hand written data
- Individually calibrated pressure ranges on two pressure sensors with traceable N.I.S.T. precision
- Accuracy calibrated on all pressure readings $\pm 0.1\%$, typically $r^2 = .99$
- Temperature Monitoring added with automatic Standard Temp adjustments to 25°C
- Completely revised Windows .NET user application package
- Installation compatibility across all Microsoft OS, Vista, Windows7, XP, NT
- Application Platform Basis on .NET, the workhorse platform for Microsoft Supported developers writing in C#

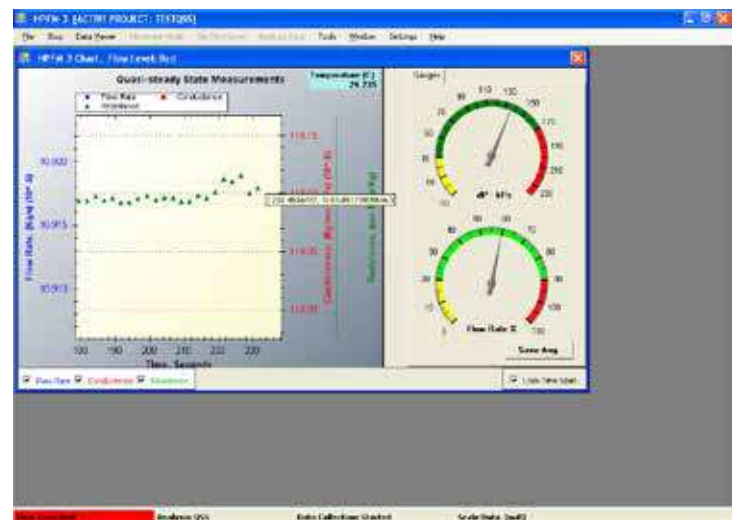
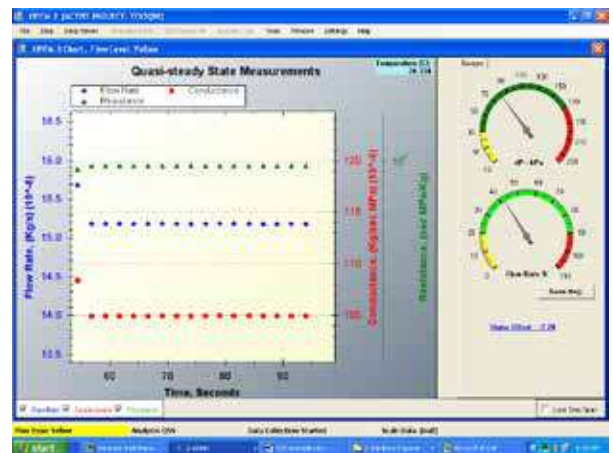

Specifications for HCFM

tem Ranges

1 mm to 36 mm diameters

Flow Rates

0.01 to 350 grams/hr in 5 overlapping ranges

Conductance

7.7E-08 to 3.5E-04 Kg s⁻¹ MPa⁻¹

Electronic A/D

24-bit resolution dual Analog / Digital converters

Analog/Digital

One reading every two seconds

Data Interface

USB, USB powered

Dimensions

22" x 19" x 9" (61 x 48 x 23 cm)

Weight

33 lb (15 kg)

Capacity

24 oz. Degassed Water

Maximum Pressure

90 psi (620 kPa)

Air Gas Tank

6 cu. ft. (170 liter) with CGA-580 Valve & Connector

New Calibrations, Improved Specifications

- Sensor zero set provided with linear and 2nd order polynomial regressions removes sensor and board drift between data sets
- Improved overlap on conductance ranges by 50% Differential pressure calibrated to 180 kPa
- Sensor Nonlinearity removal by unique software adjustment, 1-4th order effects removed
- Conductance and resistance results at the reading temperature are adjusted according to the calibration temperature
- Temperature adjustments are performed automatically to deliver results at 25° C
- Direct flow calibration increased to 15 points from 12.
- 50% increase in the flow range / pressure difference for all 6 flow ranges

New Graphic Analysis

High-resolution result graphics with dynamic zoom, detail zoom, auto scale. Steady state flow meter: results translated to

- Resistance
- Conductance (new)
- Flow (new)
- Ten Point Average Option

Large, easy to read pressure gauges are digitally painted on screen.

- Color coded ranges automatically defined
- Audible and graphic warnings provided to prevent over pressure or out of range readings
- Flow gauge readout in % of full scale as well as a detailed 2D chart in $\text{Kg}\cdot\text{s}^{-1}$
- Easy to read raw data display of all important parameters
- Set-up and control options in one menu
- Protected calibration mode
- All changes to initialization automatically backed up

Dynamic – Transient Conductance (K) with rapid conductance regression display.

- Instant regression, with chart view, save and printing options
- Re-analysis of saved data
- Two types of data exclusion: Min/Max, and Pick points to ignore

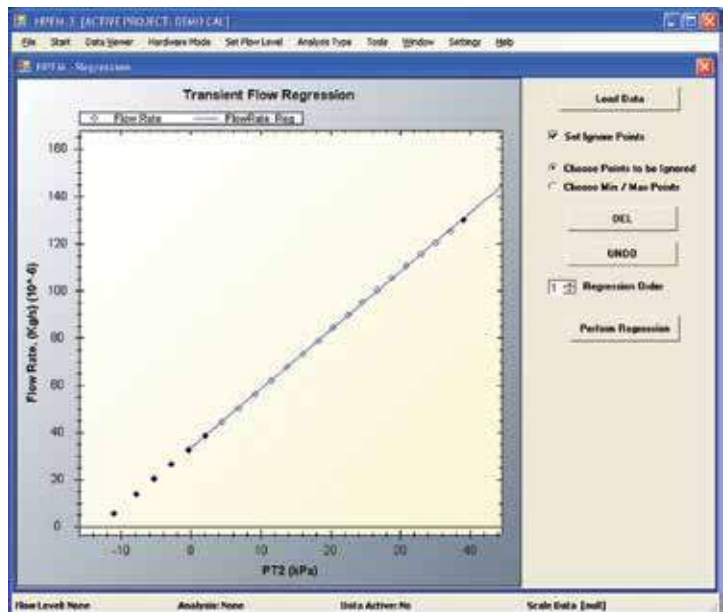

New Project Manager organization folders automatically organize your data by date. Data sets are saved to the designated folder, with comments. Calibration files, initialization and set-up files are saved separately from data.

Interactive Help Options, Documentation built into application are coming soon.

1.1 High Conductance Flow Meter (HCFM) Form & Function

The HCFM is shown schematically in Figure 1. It is an apparatus designed to perfuse water into an object while rapidly changing the delivery pressure and simultaneously measuring flow. This is referred to as a transient conductance measurement. The slope of flow plotted versus pressure equals the hydraulic conductance of the object. The object can be an excised shoot or excised root system or capillary tube (for test purposes). The HCFM may also measure quasi-steady state conductance, i.e., under conditions where flow and applied pressure are approximately constant with time.

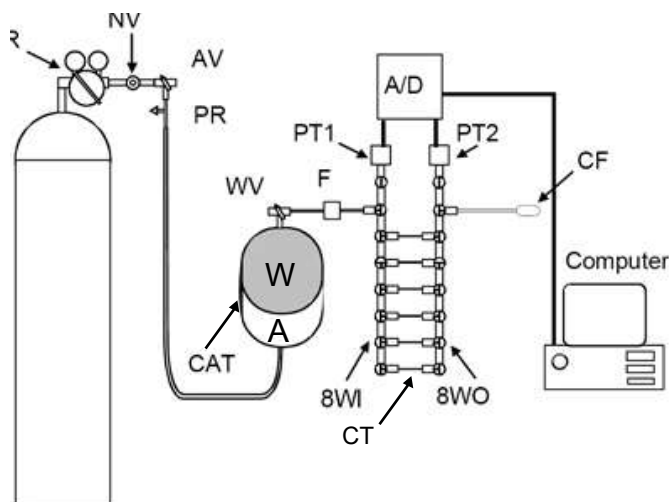

Figure 1
Schematic of High Conductance Flow Meter (HCFM)

The rapid change in water pressure is achieved using a pressure regulator (R), a needle valve (NV), and a captive air tank (CAT). A pressure regulator (R) delivers compressed air from the compressed air tank (CAT). The pressure regulator keeps the compressed air at a steady pressure of 4 to 5 MPa (580-725 PSI) through a needle valve (NV).

The NV is connected to the air-chamber (A) of a captive air tank (CAT). A rubber diaphragm separates the air from water (W) in the CAT. The NV is adjusted to permit a rate of airflow to pressurize the air volume at a rate of 3 to 7 kPa s⁻¹ (approx. 1-PSI s⁻¹). The volumes of air and water are approximately equal in the CAT. The CAT can be pressurized or depressurized by turning the 3-way ball valve (AV).

A pressure release valve (PR) prevents accidental over-pressurization. The pressure release valve is set to vent air when the pressure exceeds about 0.6 MPa (87 PSI). Since the pressure in (A) never exceeds 0.6 MPa, and the air supply is 4.2 MPa (609 PSI), the pressure drop across the NV is approximately constant. This allows the rate of pressurization in the water to be approximately linear with time.

Pressurized water flows from the CAT to the 8-Way Inlet manifold (8WI) through a 9 mm Inside Diameter (ID) nylon-reinforced Tygon tubing. At a distance of 0.3 m from the CAT the water passes through a 0.1 micron water filter, then the diameter of the tubing is reduced to 3 mm Outside Diameter (OD) plastic tube; the plastic tubing is connected to the input side of the 8WI. The 8WI is shown schematically in Figure 1. The 8WI is an 8-Way HPLC valve of octagonal geometry with 8-tubes emerging from a common point in the center and each tube terminated by a valve.

On the inlet side, the 3 mm OD (1.5 mm ID) tube from the CAT is connected to one of the 8 valves (purple connector on the HCFM). A pressure transducer (PT1) is connected to another valve (blue connector on the HCFM). On the outlet side another pressure transducer (PT2) is connected to 8WI (blue connector) as well as the 3 mm OD (1.5 mm ID) outlet tube (purple connector). This leaves 6 pairs of valves available between each 8WI and 8-Way Outlet (8WO) for connection of narrow-bore capillary tubes (CT).

The capillary tubes are 1.5 mm OD HPLC tubing 0.16 to 1.5 m in length. The HPLC CTs have internal diameters from 0.12 to 0.5 mm. During a measurement, one CT is selected by opening the inlet and outlet valves of the corresponding manifold (8WI and 8WO). The corresponding CT valves for the unused capillary tubes must be closed. Water flow across the selected CT causes a differential pressure (dP) drop ($dP = P_1 - P_2$) measured with PT1 and PT2, respectively.

Calibration curves were established relating flow, F, to dP values in the range of 0 to 180 kPa. HPLC capillary tubes up to 0.25 mm ID have linear calibration curves. HPLC capillary tubes 0.3 mm ID or larger are nonlinear because of the transition from laminar to turbulent flow. All calibrations are performed by Dynamax.

The pressure measurements are made with model PX26-100GV solid-state strain-gauge transducers. The output of the pressure transducers is logged using a custom-designed, dual channel A/D circuit with 12 bits plus sign accuracy. The HCFM is supplied with Windows software for controlling the A/D circuits, logging data, and for preliminary data analysis.

The Flow Outlet side of the 8-Way manifold is connected by a 6-foot (1.8 m) length of water-filled 1.5 mm ID Teflon FEP "Clear" tubing to a compression fitting (CF). This FEP tubing permits connection to the larger size plant or root base with 19-50 mm fittings (HPCC19-35 and HPCC34-50). Additional (1 mm ID) HPLC "Natural" (light tan) tubing is supplied for use on smaller sized roots and shoots with 1-20 mm fittings (HPCC 1-4, HPCC 4-10 and HPCC 10-20). We also supply 0.127 mm ID 'RED' tubing, which is used to assist air bubble removal in the system AND to use for test measurement. This red tube has the conductance of a small seedling with about 100 to 200 cm² of leaf area. A range of compression fittings is supplied to permit connection to stems ranging from 1 to 50 mmOD.

1.2 Personal Computer Requirements

The program that controls the High Conductance Flow Meter is Gen3 is installed under a program file directory, to run the software use an IBM compatible computer with an 800 x 600 pixel screen or better. The computer must be running on 32-bit Windows XP/2000/Vista, 64-bit WindowsXP/2000/Vista, or Windows 7. Two USB ports are required, one to communicate with the usb-2404UT analog converters, and one for the USB "Keylock" USB dongle, provided for access to each customer's unique HCFM.

The software is installed from a single CD ROM via an Install Shield Wizard in the same manner as most Windows software. The install shield Wizard will install the program in:

C:\Program files\Dynamax\HPFM.ini

There are five distinct parts to software installation, allowing customers to leverage software created independently, by Microsoft, Measurement Computing, USB software experts and Dynamax Inc. Installation is covered in detail in Section 4.

1. Install latest Microsoft. NET, if required, the Visual c. frameworks.
2. Install the Dynamax, HCFM.exe, and the graphics drivers, calibration files, initialization files, and example data.
3. Install Keylock, the security key to enforce Dynamax copyright protection.
4. Install measurement computing InstaCal, the analog conversion utility incorporated into our product.
5. Install USB device drivers, that access and control the USB data converters.

See **Section 4**, "*HCFM Installation Guide*" for the steps to install the HCFM software:

Dynamax supplies the HCFM with a professional factory calibration traceable to NVLAP calibrate scales and pressure transducers. The calibration file is included on the software disk under the file name HCFM.ini.

1.3 Pressured Bottle Requirements

Dynamax ships the HCFM-C models with a compressed air tank, regulator, and hose for connection to the HCFM. This tank can be pressured to 1850 pounds per square inch (PSI) or 12,755 Kilo-Pascal's (kPa). It has a volume of 6 cubic feet (Cu. Ft.) or 170 liters. The regulator allows control of pressures up to 3000 PSI or 20,685 kPa. This air tank or bottle cannot be shipped filled, so you will need to fill the bottle (air tank) with a **dry** compressed gas. Economically, two gases are best: Nitrogen or dried compressed air. The compressed air tank can be filled by University physical plants (they can assist you) or distributors such as Air Liquide, Linde, or BOC Gases. The setup for running a transitory test requires enough pressure (600 PSI or 4,100 kPa) to deliver a constant flow of gas to the HCFM. The pressure regulator requires about 700 PSI in the tank to deliver 600 PSI to the HCFM. It must deliver the gas without "choking" and causing a reducing flow of gas over the time period of the test.

WARNING!

The compressed air tank must have at least 700 PSI (4,800 kPa) to run a transient pressure test.

1.4 Unpacking

The HCFM is supplied as a complete unit. No assembly is required. However, there are several accessories that are packaged with the system such as:

- **O-rings**
- **Compression caps**
- **Connection and bleeding hoses**
- **Compression Couplings**
- **Communications Cable**
- **Manual and Software**

It is recommended that you take a few minutes to check off and confirm all of these components were received. A detailed Parts and Packing List is below.

1.5 What to Keep!**NOTE:**

When unpacking, do not discard the box and packing material.

Dynamax ships the HCFM in a box with material on all six sides, this makes the shipping box the perfect box for you to keep and ship your HCFM internationally, across the U.S., or back to Dynamax for an annual calibration. Also keep the Lists of Parts, the software, and the accessories that came with the HCFM. The list will come in handy when reordering parts for the HCFM. The software should be kept as a backup in case of PC failure such as hard drive corruption. The accessories should be kept in the lid of the HCFM since they will be needed to use the HCFM on a daily basis.

HCFM-XP Gen 3 Packing List

HCFM-XP	Hydraulic Conductance Flow Meter with software CD, calibration documentation
1401	Small O-Rings (10 Pack)
1402	Large O-Rings (10 Pack)
1535	.005"ID X 1/16" OD 5ft. red peek tubing
PM-2040	.042" (1mm), HPLC 5ft Nat. peek tubing
EW-06406-62	1/16" ID X 1/8" OD 6ft Teflon rigid tubing
HPCC 1-4 1001	1-4mm Two Way Connector
HPCC 4-10 1008	4-10mm Universal Connector
RSW502	3/8" Cone Washer for 8-10mm Range
HPCC10-20	10-20mm Compression Coupling with rings
HPCC19-35	19-35mm Compression Coupling with rings
# 6/12	# 6/12 Rubber Stoppers (Drilled 6)
# 10	# 10 Rubber Stoppers (Drilled 9)
G4	Silicone Coupling Grease with MSDS
Keylock	USB keylock with Lanyard
	Plastic Compression Nuts (2)
	Spare 9v Alkaline Battery
	Refill bottle
	3cc & 30cc Syringes, blunt end 1 3/8 and 7/8 needles, Blade
	Algaecide 60 with Safety Sheet

2. Quick Start Guide

This section is designed to provide a recipe style reference guide to present the basic steps you should follow to assist the new user to begin using the HCFM. The manual then provides more detailed instruction on how to complete each step.

1. Fill the Air Supply Tank with Compressed Air or Nitrogen – **Section 5.0**
2. Prepare 2 L of degassed, de-ionized water – **Section 5.4.1**
3. Prime the Captive Air Tank of the HCFM with degassed deionized water – **Section 5.4**
4. Eliminate all air from the HCFM by purging air from the CAT and Tygon supply tubing, through the purge valve and water filter purge caps. Then bleed the system with the small Red capillary tube over night to remove any microscopic air bubbles that may have remained in the CAT or the 8-Way valve manifolds. – **Section 5.5**
5. Insert the security lock provided with each HCFM. Connect the HCFM to a PC via the computer's USB Port and the communication port on the HCFM with the communications cable. – **Section 6.0**
6. Check the LED on the HCFM and launch the program by clicking on the HCFM3 icon. Listen for a beep, and notice the green LED blinking on the USB-2404UI Analog Module. Open a project file folder to collect data, or reopen an old project file – **Section 6.2**
7. Set the Zero Flow Volts to zero the transducers before taking measurements. This must be performed each day before beginning measurements to ensure accuracy – **Section 6.3**
8. Select the plant that you will be working with and measure the stem size – **Section 9.0**
9. Cut the sample plants stem and install the Pressure couplings – **Section 9.0** Use (1 mm ID) HPLC "Natural" (light tan) tubing with fittings 1-20 mm (HPCC 1-4, HPCC 4-10 and HPCC 10-20) and (1.5 mm ID) Teflon HPLC "Clear" tubing with fittings 19-50 mm (HPCC 19-35 and HPCC 34-50)
10. Determine the correct flow range to use for your selected sample. If you do not have the correct flow range set, your measurements will be over-scale and you may think the system is not functioning properly. – **Section 6.4**
11. For roots begin your experiment with a Transient Measurement function, as this is the quickest method for gathering hydraulic conductance data and will minimize any plugging effects caused by the plants natural healing process. For large stems you may need other methods – **Section 6.5**
12. After collecting transient flow data you can immediately perform a Regression analysis of the data using the HCFM software to determine the Hydraulic Conductance of the sample plant. The temperature of the test is automatically recorded and a correction will convert raw reading to the test temperature KC, and K25- converted to standard temperature – **Section 6.5.2**
13. As your understanding of the system develops, begin using the Quasi-Steady State Flow Meter function. By measuring total resistance of the sample you can determine the contribution that individual components make to the overall hydraulic conductance of the plant. – **Section 6.6**
14. Before beginning an intensive experiment be sure to understand all the necessary tips and cautions required to measure hydraulic conductance successfully – **Section 8.0**

3. Application and Theory of Operation

3.1 Why use the HCFM?

The High Conductance Flow Meter has several uses in the analysis of root/shoot studies. Some examples of the uses of the HCFM are:

- Root conductance in the lab or field
- Conductance of shoots and petioles with or without leaves
- Root Stress Analysis on trees or crops
- Modeling root to shoot communications
- Transpiration models
- Root water status studies
- Absolute varietal comparison statistics
- Mycorrhizae nutrient/water enhancement studies
- Soil to root conductance statistics
- Crop conductance studies

3.2 Transient Measurements Conductance of Roots

Experience has shown that during flow measurements on roots, flow frequently declines even when the applied pressure, P_2 , is constant. Reasons for this include:

1. During perfusion, solutes accumulate in the stele by reverse osmosis causing a continual decrease in driving force on water movement.
2. Natural wound responses induced when the shoot is excised cause plugging of the xylem within the first few centimeters of the wound causing a continual decline in K .

Readers are referred to (Tyree et al. 1993 and Tyree et al. 1995) for details. Consequently, the HCFM has been designed to measure K quickly before the above effects become serious enough to influence K . Doing rapid measurement raises other sources of error that need to be addressed.

The rate of water flow into roots, F , will exceed the rate of passage through the roots, F_h , if the root is initially dehydrated since some of the water will remain behind to re-hydrate cells. But F will exceed F_h even in fully hydrated roots because pressurization will cause elastic swelling of the roots or the HCFM. F will also exceed F_h because of compression of any air-bubbles that might be present in the wood, the stem interface, or the HCFM. So F will be given by:

NOTE:

It is essential that users of the HCFM are aware of potential sources of error and know of ways to minimize such errors

$$F = F_h + F_e + F_b \quad (5)$$

Where: F_e is the flow associated with elastic swelling and F_b is the flow to compress air bubbles (when present).

If the flow through the object measured is a linear function of applied pressure difference between the outlet of the HCFM and atmospheric pressure, we can express F_h as:

$$F_h = K P_2 \quad (6)$$

Where: P_2 is the outlet pressure relative to atmospheric pressure. The volume of the tubing, connectors, and object measured will increase with P_2 . If the volume increase is elastic and linear with pressure, then the volume of the system, V , will be given by:

$$V = V_0 + P_2/e \quad (7)$$

Where: V_0 is the initial volume of the system at $P_2 = 0$ and e is the bulk modulus of elasticity. The time derivative of Equation (7) gives the flow to cause the elastic volume change:

$$F_e = dV/dt = (1/e) dP_2/dt \quad (8)$$

If air bubbles are present anywhere in the system, they will be compressed according to the ideal gas law as the pressure of the fluid around the bubble increases. If V_b is the volume of a bubble at absolute gas pressure P_b then the ideal gas law gives:

$$P_b V_b = nRT = P_i V_i \quad (9)$$

Where: n is the number of moles of gas in the bubble, R is the gas constant, T is the Kelvin temperature, and P_i is the initial gas pressure and V_i is the initial volume. If we write Equation (9) as $V_b = V_i P_i / P_b$ and take the derivative with time we get the rate of volume change of the bubble:

$$dV_b/dt = -(V_i P_i / P_b^2) dP_b/dt \quad (10)$$

The negative sign of the derivative indicates that V_b decreases with increasing P_b . The flow of water to compress the gas volume is the negative of Equation (10) so we have:

$$F_b = -dV_b/dt = (V_i P_i / P_b^2) dP_b/dt \quad (11)$$

In the case where all of the air bubbles are near the outlet side of the flow meter, we can equate P_b to $P_2 + P_i$. P_i is the initial absolute pressure of the bubble when $P_2 = 0$. P_i approximately equals 0.1 MPa. The barometric pressure will determine the P_i . There will also be a small contribution by the surface tension of the air-water interface to bubble compression. In the special case where the air bubbles are near the outlet of the flow meter, the dynamic flow will be given by substituting Equations (6, 8 and 11) into (5):

$$F = K P_2 + (1/e) dP_2/dt + V_i P_i / (P_2 + 0.1)^2 dP_2/dt \quad (12)$$

During normal operation of the HCFM, the inlet pressure P_1 increases linearly with time, and after a short time delay this causes P_2 to increase linearly with time to make dP_2/dt equal to a constant. This permits easier interpretation of results because it makes the elastic contribution a constant offset to F_h . The contribution of the three terms in Equation (12) is illustrated in Figure 2 for the case where P_2 increases linearly with time from time = 0 (Figure 2 (A)). The component flows (F_h , F_e , and F_b) and total flows are shown in the below.

It is not possible, in practice, to make P_2 increase linearly with time from time 0. This is because an extra conductance

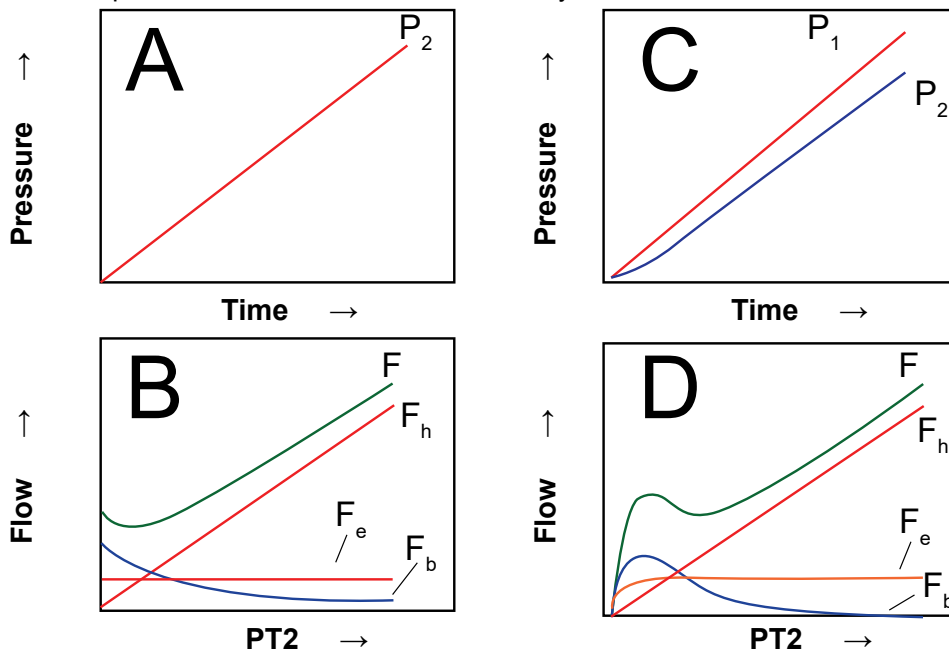

Figure 2
Transient Measurements Conductance of Roots

equal to the conductance of the capillary tubes of the HCFM (KCT) is interposed between the pressure transducers that measure P1 and P2 (see Figure 1). When the full set of equations is derived (not shown) a short time lag is predicted before P2 increases linearly with time (see Figure 2 (C)). The resulting component and total flows are shown in Figure 2 (D).

Air bubbles generally can be avoided within the flow meter tubing and apparatus, but sometimes air is in the vessels and/or intercellular air spaces in the base of roots. Although the compression of air causes an increase in F at any given P2 during a transient measurement, bubbles cause an underestimation of the root conductance, Kr. This is because Fb decreases with increasing P2 causing a negative contribution to the slope used to calculate Kr. Fortunately, the contribution of bubble compression to total flow diminishes with increasing pressure. The slope of the F versus P2 for P2 > 0.25 MPa is a reasonable approximation of the hydraulic conductance of the root system being measured. It is probably good practice to measure transient flows for P2 up to 0.5 MPa in order to reduce the underestimation of Kr caused by compression of air bubbles.

3.3 Quasi-steady State Measurements of Hydraulic Resistance, QSS

During steady-state measurements of QSS, water flow and applied pressure are both constant and by definition the water flow into the object measured equals the flow out of the object. In practice it is never possible to keep flow and pressure perfectly constant, so it is best to refer to such measurements as quasi-steady state.

The capillary tubes (CT) on the HCFM have been calibrated, i.e., their conductance, KCT, or resistance RCT = 1/KCT, has been measured. During flow measurements, the control program monitors the difference in pressure dP across the CT. The program uses dP to calculate the flow, F, from:

$$F = KCT \, dP \quad (1A)$$

or
$$F = dP/RCT \quad (1B)$$

Since the flow into the object closely equals the flow out, the unknown hydraulic resistance, RU, can be calculated from:

$$RU = (P2 - PO) / F \quad (2A)$$

or
$$KU = F/(P2-PO) \quad (2B)$$

Where: P2 is the pressure recorded by the pressure transducer at the outlet, PT2, and PO is the pressure of the water where it emerges from the object. In many cases PO is known to be zero. When PO is unknown then RU or KU cannot be computed. Examples will be given later of instances where PO is unknown. For the rest of this section we will assume PO = 0 and can be omitted from the equations.

Another useful way of viewing Quasi-steady state measurements is through the Ohm's law analogue for flow through resistance in series. For any given resistance, R, in series Ohm's law states that:

$$RF = dP \quad (3)$$

So for the capillary tube in series with the unknown resistance we have:

$$RCT \, F = dP \quad (4A)$$

and
$$RU \, F = P2 \quad (4B)$$

So dividing Equation (4B) by (4A) we have:

$$RU/RCT = P2/dP \quad (4C)$$

or
$$RU = RCT \, P2/dP \quad (4D)$$

or
$$KU = KCT \, dP/P2 \quad (4E)$$

4. HCFM Installation Guide

Please use the following steps to install the HCFM Software onto your PC.

1. Login as an **administrator level user**.

WARNING!

The HCFM software will NOT OPERATE PROPERLY unless your signed in as the Administrator user. Turn off Virus Protection and all other applications.

2. Insert the HCFM3 CD in your CD drive. Use Windows Explorer to browse to the root of the CD. For Windows Vista and Windows 7 users.

3. Right click **Setup.exe** and select **Run as administrator**.

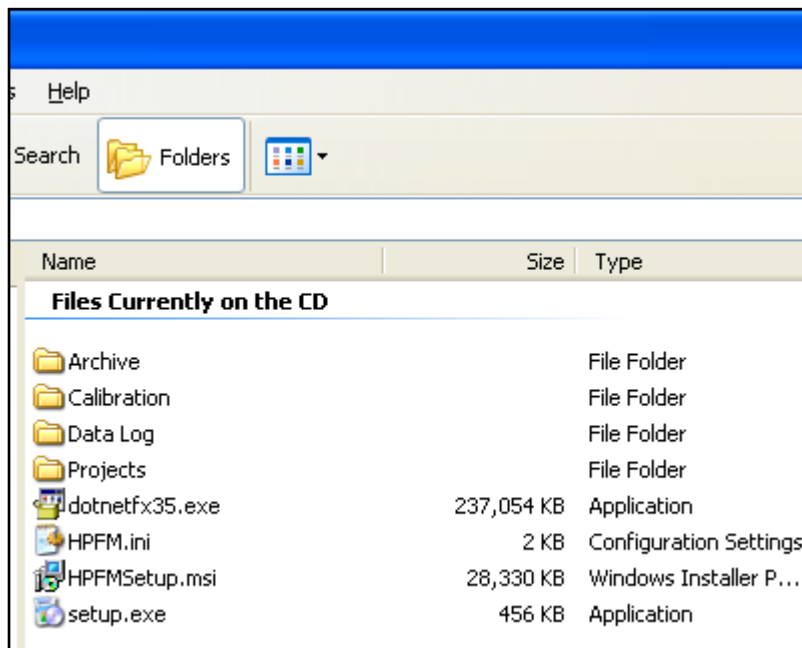

4. Navigate to Start Menu - Control Panel – Add/Remove Programs and check if Microsoft.NET framework 3.5 or newer version is available on your PC.

NOTE:

For Windows Vista and 7 users, Microsoft.NET framework 3.5 is not required and the default version on your computer is version 4.0.

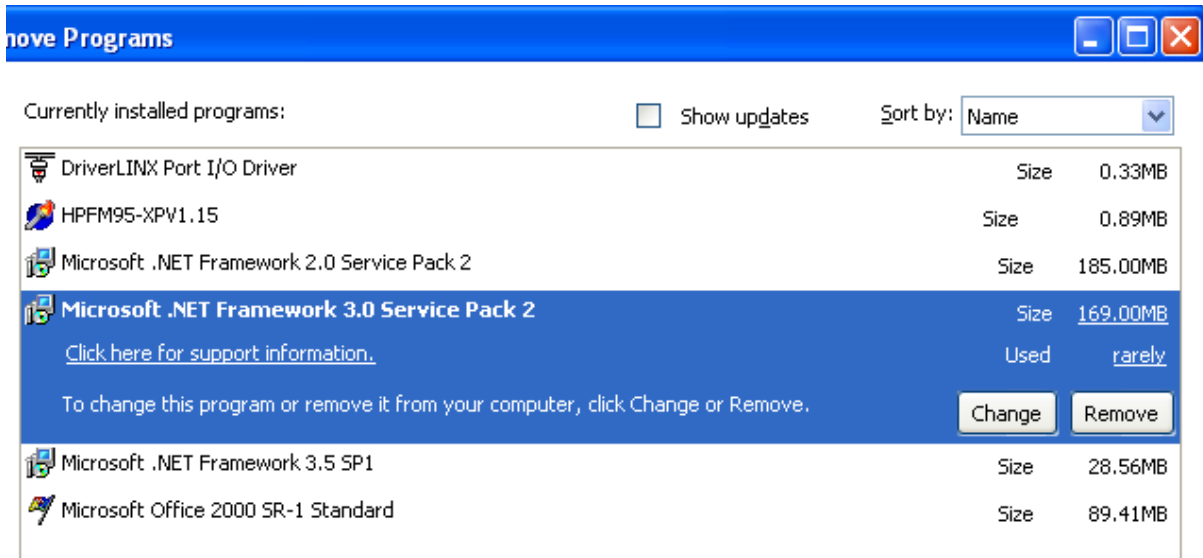

5. If upgrade is needed, double-click on dotnetfx35.exe in your CD directory and follow the instructions on the installation dial

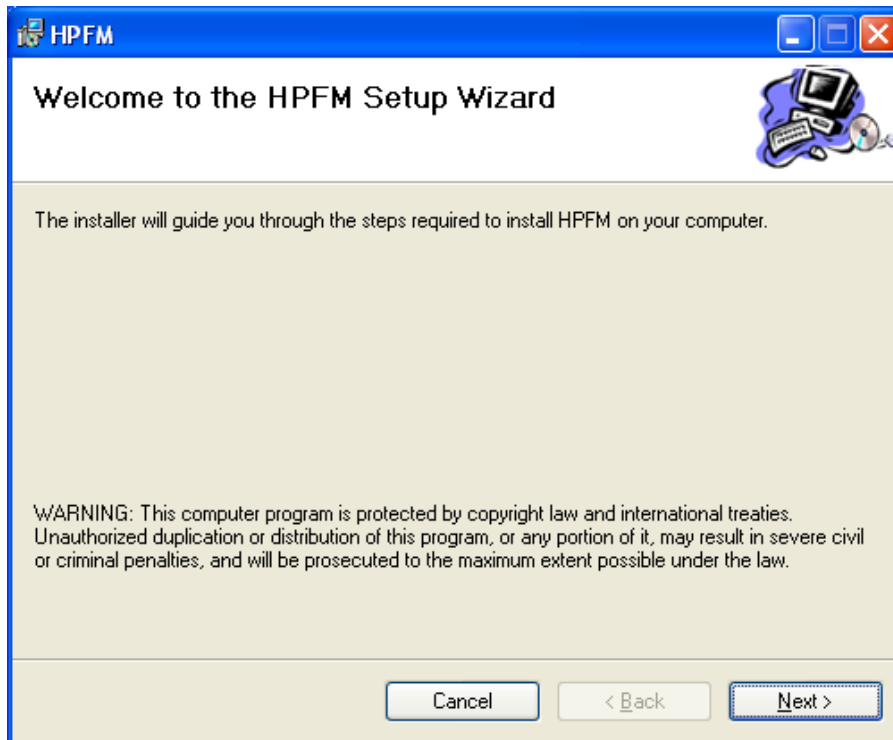

6. After .NET Framework 3.5 installation is completed, double-click on setup.exe to install HCFM software.

7. Choose directory where you want the software to be installed at (use default directory C:\Program Files\Dynamax\HCFM).

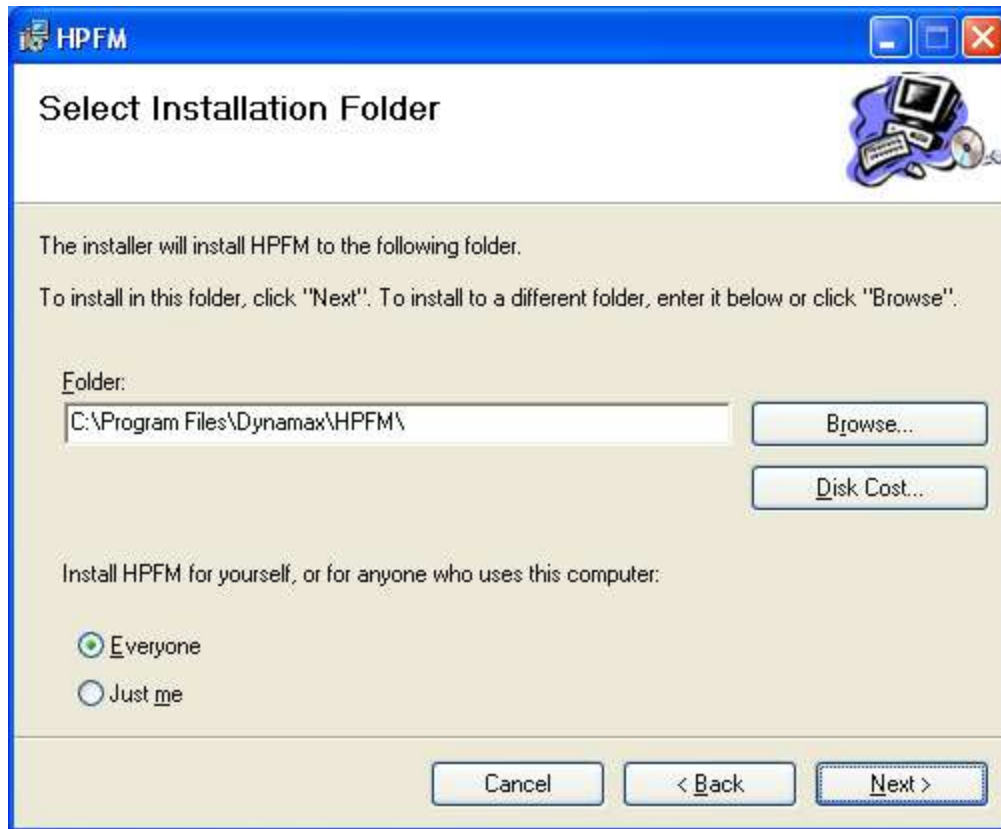

8. After the HCFM installation, setup.exe will automatically install Security Key driver. This USB device is used in conjunction with HCFM for security purpose. Click **OK** to exit this screen when completed.



9. Next, the process installs the Measurement Computing (MC) - hardware communication and analog data acquisition software (InstaCal).

10. A new self-Extractor screen will pop up to ask your permission to continue the installation. Click **OK** to proceed.



11. The installation of InstaCal program will start, which is essential to HCFM operation. Click on **Setup** to continue.

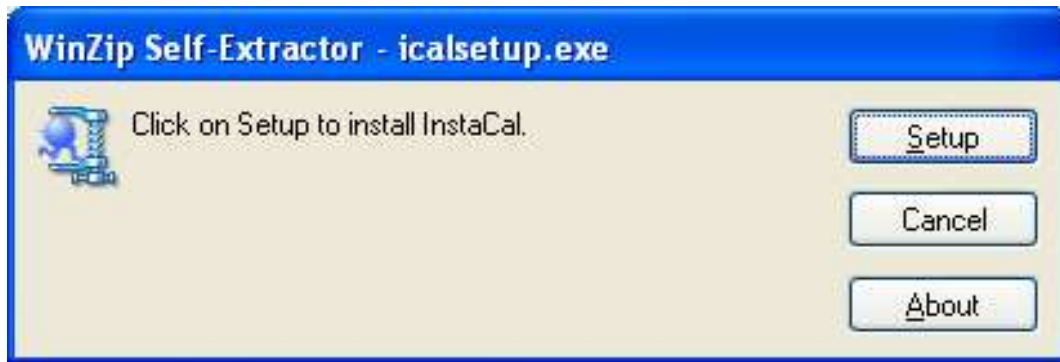

12. Click on **Next** and choose installation directory (use default location).

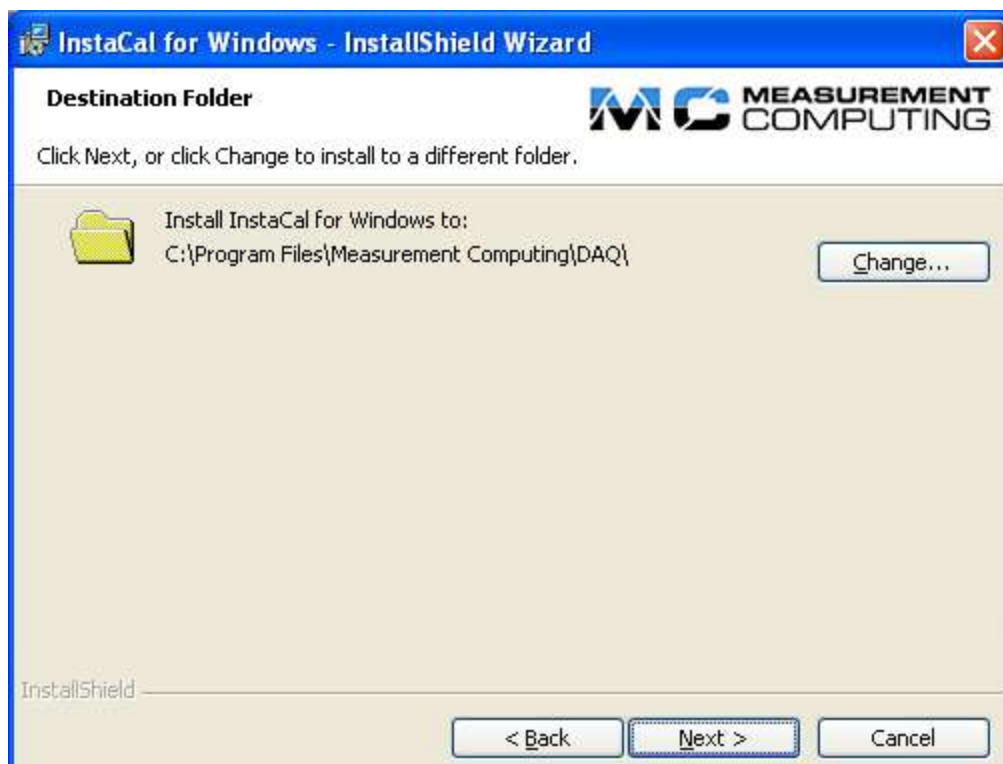

13. Windows will prompt you to restart your computer after installing all of the above products. Click on **Yes** to restart.

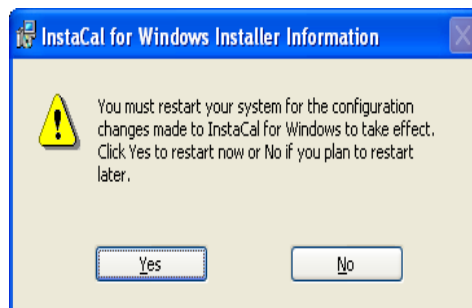

14. A successful installation should have the following:

- HCFM and InstaCal icons on your desktop



- HCFM directory located at C:\Program Files\Dynamax\HCFM\HCFM.ini is a setting file, which matches the calibration data supplied for your serial number and calibration document.

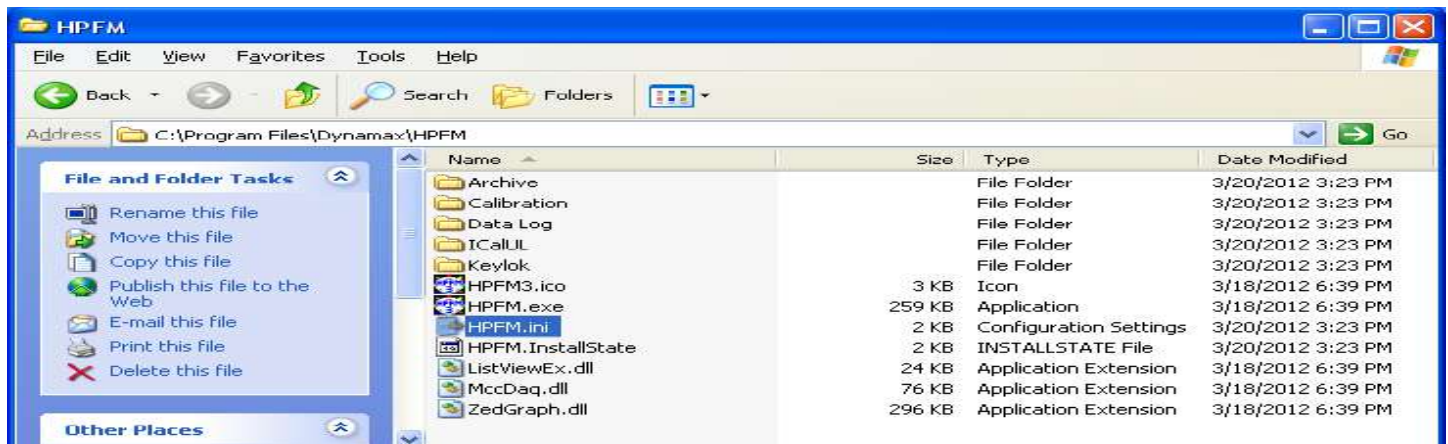

- MC is directory located at C:\Program Files\Measurement Computing\DAQ\

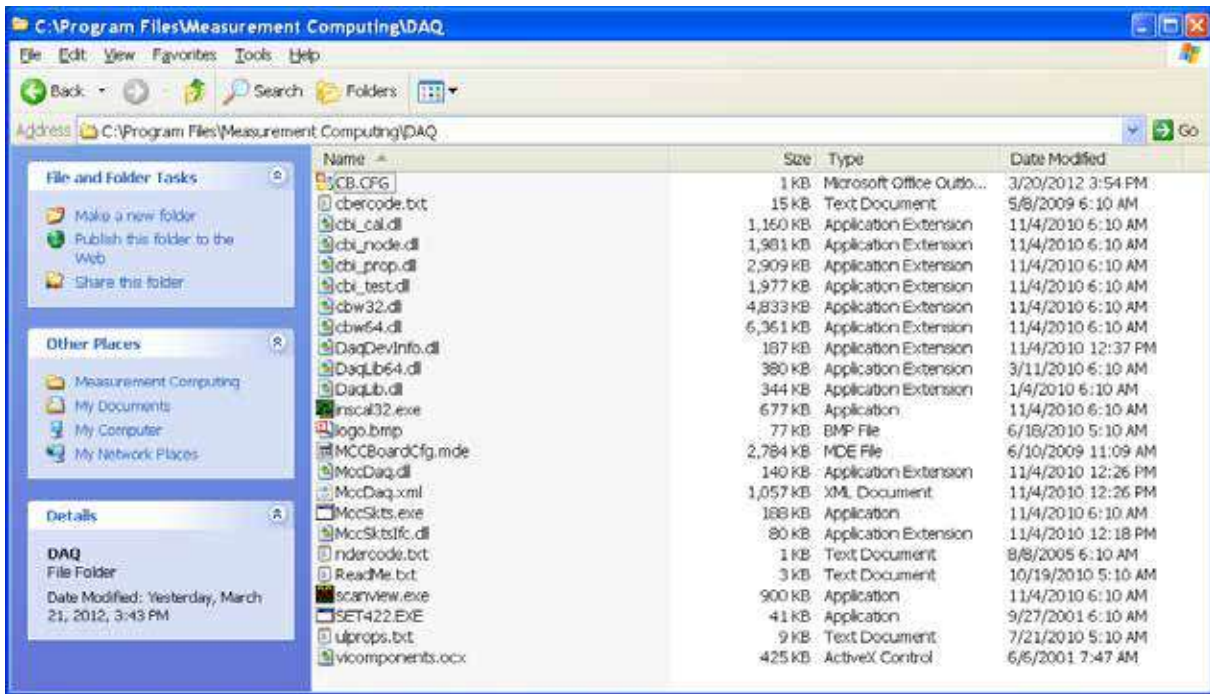

Note

The cb.cfg file is unique for the HCFM application. The .CFG file defines the A/D channels and configures them for the pressure readings.

15. For **32-bit Windows** XP/2000/Vista:

in order for HCFM to read pressure, check, and then copy if needed the CB.CFG file from:

C:\Program Files\Dynamax\HCFM\calUL\ CB.CFG

has been copied to:

C:\Program Files\Measurement Computing\DAQ\.

For **64-bit Windows** XP/2000/Vista:

copy the CB.CFG file to

C:\Program Files(X86)\Measurement Computing\DAQ\.

For Windows 7:

copy CB.CFG to

C:\ProgramData\Measurement Computing\DAQ\.

16. After installing the CFG files, we will add two drivers for USB communication. Plug the HCFM USB cable into one of the USB port on your PC, and connect to the Measurement Computing USB2404-UI device under the top of HCFM.



When prompted for New Hardware Found, select **Yes**, this time only and click **Next**. Please select Install the software automatically.

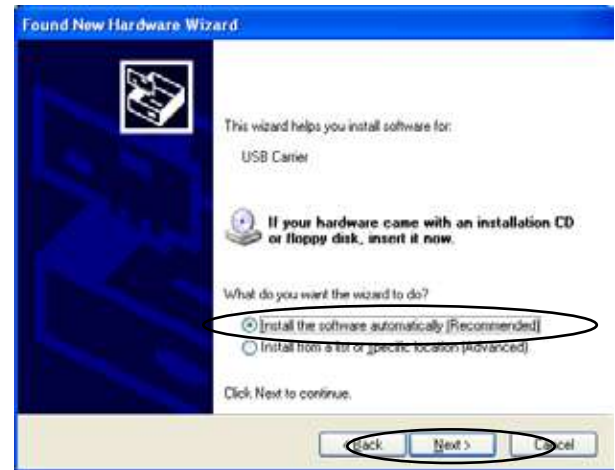

Another screen will pop up to notify you that a new device has been detected, click OK to add. The USB carrier is the generic loader for the USB2404 device.

Click **Finish** when done.



When a fully installed the USB Carrier drivers wizard will say:

17. Unplug and reconnect the USB cable between the HCFM and the computer USB port. Allow one minute for Windows to detect the USB2404-UI hardware, and install the software protocol drivers.

When prompt **New Hardware Found**, select **Yes**, this time only and click **Next**. Please select Install the software automatically.

USB2404-UI is the protocol for our HCFM-Gen3 to communicate directly with the USB driven MC module (as opposed to a USB driver that uses a COMx port.)



The next time you plug in the USB cable to the A/D converter, there will be a message that the USB device is installed.

Now, the green LED on the USB2404-UI unit should start blinking.



To review a proper installation, of if there is any doubt, one may check the device manager to see the USB2404-UI device listed under the DAS Component list:

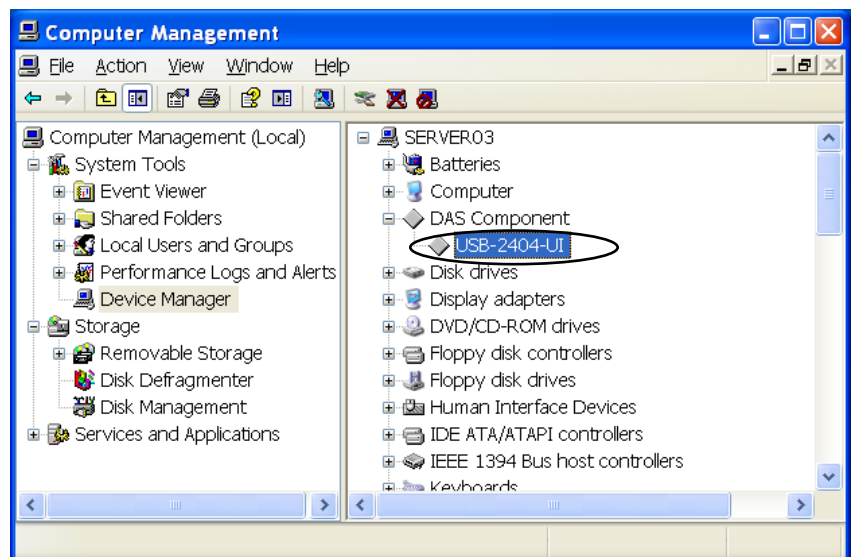

18. After installing the device drivers, open the InstaCal program from the desktop or the START menu. Before actively using the icons the serial number must be highlighted.

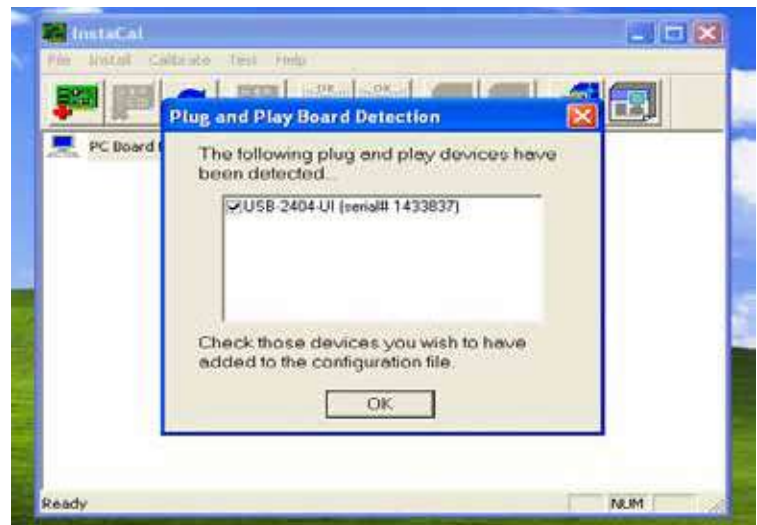

Then, click on **Configure** icon to confirm the settings.



19. Select tab USB-2404-UI, check the settings, and if required make the following changes:

- ADC Timing Mode: Best 60Hz Rejects (DO NOT use any other timing modes in the list)
- Temperature units: Celsius

Once these changes have been made click **OK** and proceed to the next step.

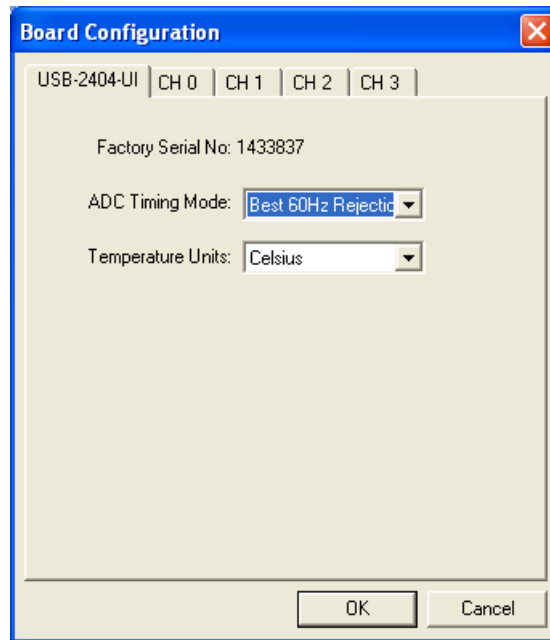

20. While under CH0 settings make the following changes:

- Channel Mode: Bridge
- Bridge Type: Full Bridge
- Range: +/-62mv/v

Once these changes have been made click **OK** and proceed to the next step

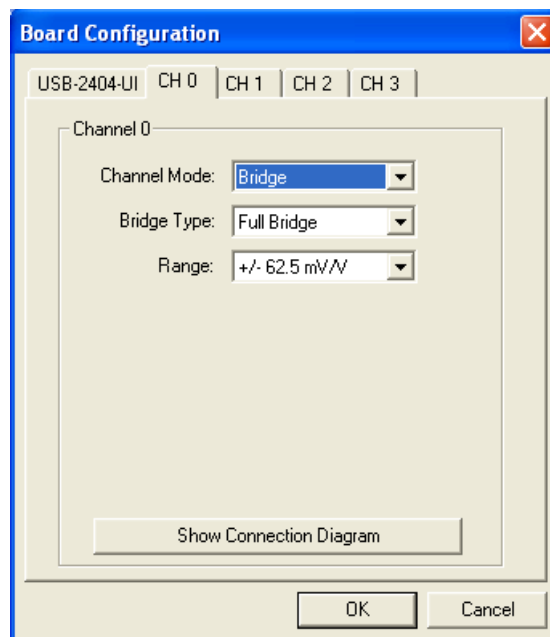

21. While under CH1 settings make the following changes:

- Channel Mode: Bridge
- Bridge Type: Full Bridge
- Range: +/-62mv/v

Once these changes have been made click **OK** and proceed to the next step

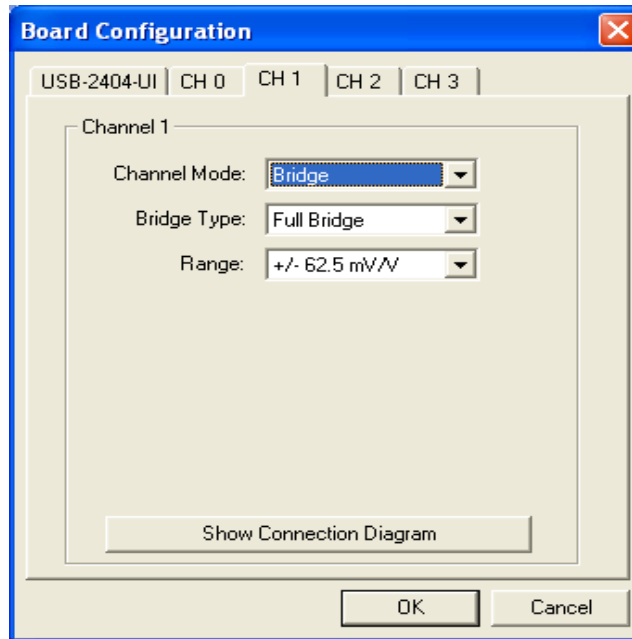

22. While under CH2 settings make the following changes:

- Channel Mode: Thermocouple
- TC Type: Type 2

Once these changes have been made click **OK** and proceed to the next step

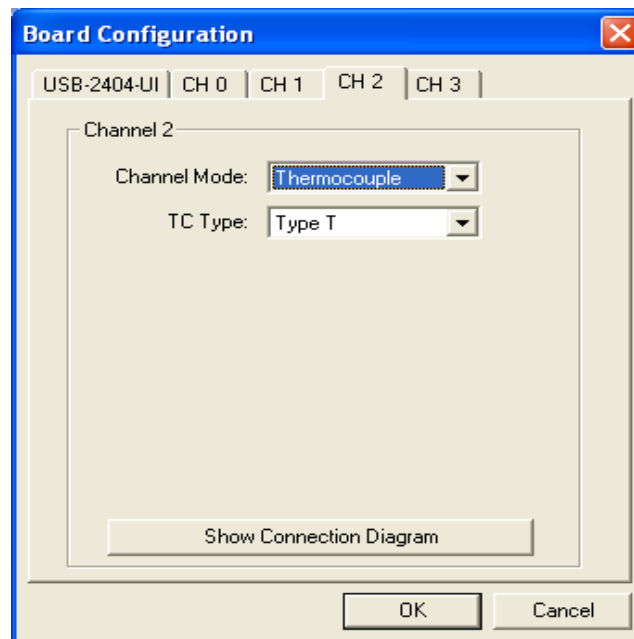

23. At this time, or if any future need arises for a quick hardware test, you may run the InstaCal test.

Check on the “Test” tab and select the ANALOG option. A diagnostic screen will appear.

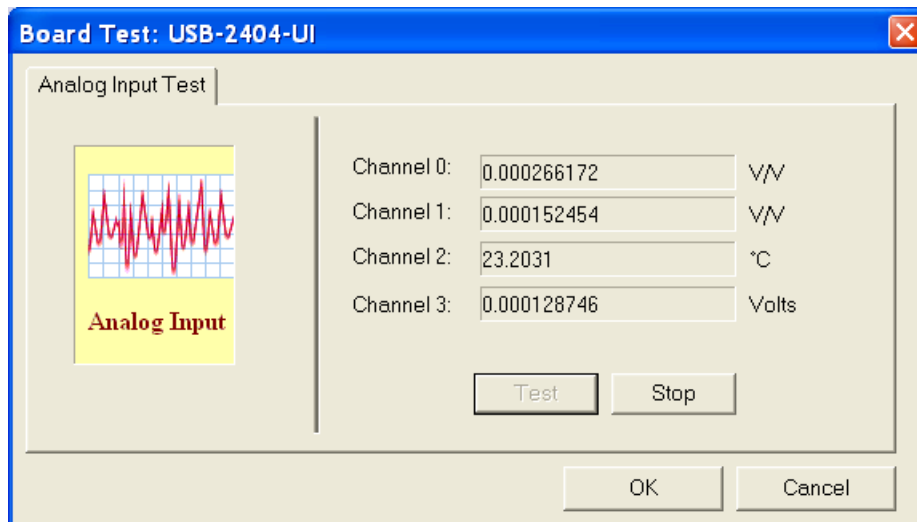

The voltages at zero pressure should be as shown, less than .004 V (<1 micro V) at maximum pressure (560 kPa) applied, the voltage is about .008 V, see the calibration section for details on other pressure/ voltage comparisons. A valid temperature in degrees C, should appear as well.

Now that you have properly installed the program and configured the system, you are ready to run HCFM.

24. Double check your Calibration table. This step is to ensure that correct calibration table is copied into your HCFM directory

25. Go to your CD ROM drive, open “HCFM.ini” from the root directory with Notepad.

26. Then, go to your HCFM installed directory at C:\Program Files\Dynamax\HCFM and open the same file name “HCFM.ini” with Notepad.

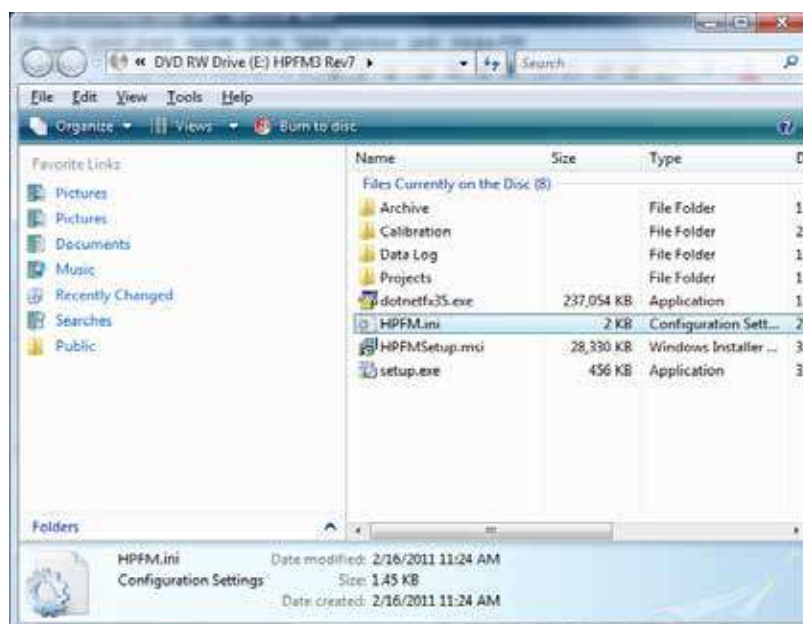

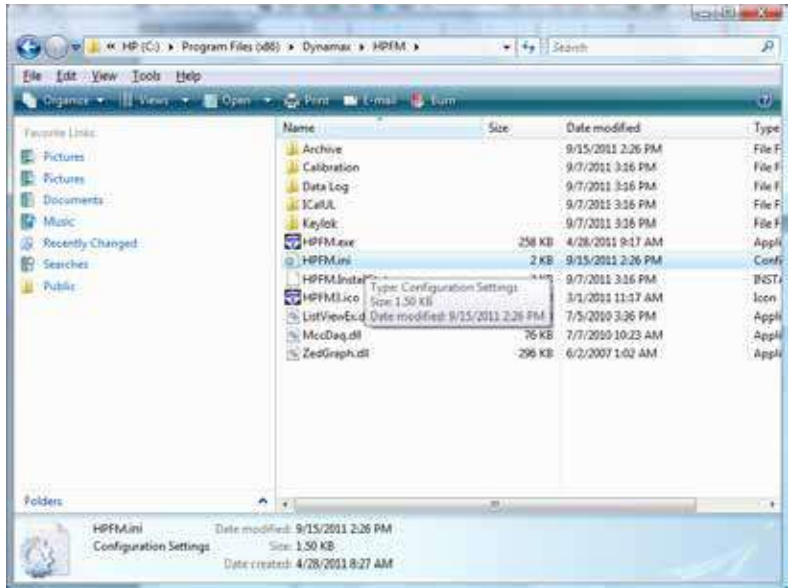

27. Compare the contents of the two files. If they don't match, copy it from CD and paste into the installed directory mentioned above and overwrite the existing HCFM.ini document.

```

HPPM.ini - Notepad2
File Edit View Settings ?
1 [SCALE_COMPFORT_NAME]COM1
2 [SCALE_COMPFORT_BAUDRATE]2400
3 [SCALE_COMPFORT_DATABITS]7
4 [SCALE_COMPFORT_PARITY]None
5 [SCALE_COMPFORT_STOPBITS]One
6 [SCALE_COMPFORT_LPCR]True
7 [SCALE_COMPFORT_ESC]True
8 [SCALE_COMPFORT_DTR]True
9 [SCALE_COMPFORT_CMD]P
10 [DATA_LOG_PATH]C:\Program Files\Dynamax\HPPM\Data Log
11 [ARCHIVE_PATH]C:\Program Files\Dynamax\HPPM\Archive
12 [PROJECT_PATH]C:\Documents and Settings\nvb.DYNAMAXNEW\My Documents\HPPM-Projects
13 [CALIBRATION_PATH]C:\Program Files\Dynamax\HPPM\Calibration
14 [P1_MAX]560
15 [DP_MAX]200
16 [GREEN_FLOW_MAX]1.4E-06
17 [ORANGE_FLOW_MAX]3.7E-06
18 [RED_FLOW_MAX]1.7E-05
19 [YELLOW_FLOW_MAX]3.6E-05
20 [GRAY_FLOW_MAX]0.000105
21 [BROWN_FLOW_MAX]0.0008
22 [GREEN_FLOW_CAL_TEMP]21
23 [ORANGE_FLOW_CAL_TEMP]21
24 [RED_FLOW_CAL_TEMP]21
25 [YELLOW_FLOW_CAL_TEMP]21
26 [GRAY_FLOW_CAL_TEMP]21
27 [BROWN_FLOW_CAL_TEMP]21
28 [DISPLACEMENT]9.8960E-01
29 [P1_CAL]1,1.9568E-01,1.4601E-02,0.0000E00,0.0000E00,0.000000
30 [P2_CAL]1,2.0429E-01,1.4441E-02,0.0000E00,0.0000E00,0.000000
31 [dp_ZERO_CAL]4,6.2502E-01,-3.7929E-03,-9.1577E-06,5.4688E-08,-5.1213E-11,0.000000
32 [dp_SETZERO_CAL]1,2.0449E-01,-2.2072E-04,0.000000
33 [GREEN_FLOW_CAL]1,-3.0002E-08,5.3580E-09,0.0000E00,0.0000E00,0.000000
34 [ORANGE_FLOW_CAL]1,0.0000E00,1.5592E-08,0.0000E00,0.0000E00,0.000000
35 [RED_FLOW_CAL]1,-1.0933E-07,5.3977E-08,0.0000E00,0.0000E00,0.000000
36 [YELLOW_FLOW_CAL]1,0.0000E00,2.8823E-07,0.0000E00,0.0000E00,0.000000
37 [GRAY_FLOW_CAL]2,-3.5775E-07,4.8477E-06,-8.5422E-09,0.0000E00,0.000000
38 [BROWN_FLOW_CAL]2,-1.3680E-06,2.0289E-05,9.4173E-09,0.0000E00,0.000000
39 [HP_OFFSET]-0.50
Ln 20: 40 Col 24 Sel 0 1.49 KB ANSI CR+LF INS Configuration Files

```

DO NOT make changes to this ini.file. The settings menu, and the data viewer allows for editing the values if necessary. Normally this is not required except by a certified Dynamax technician.

5. Setup for the HCFM

5.1 Operational Imperative

From the start, it is imperative that users of the HCFM take the following steps:

1. Always test for air bubbles in the HCFM prior to starting experiments. See **Subsection 5.5**, “*Eliminating Air from the HCFM*” on use of software for methods of testing for air bubbles. Please see **Subsection 8.0**, “*Tips and Cautions*” as well.
2. Connections between the Purple outlet of the 8WO and the compression fitting on the object must be checked. In order to reduce elastic flow, always use small-diameter, rigid outlet tubing when using the two lowest flow rate ranges (Green, Red and Orange). For high flow ranges (Yellow, Gray and Brown) you may use the clear 1.5 mm ID Teflon FEP “Clear” tubing supplied by Dynamax. For low flow ranges (Green, Red and Orange) ONLY use the 1.0 mm ID “Natural” (light tan) HPLC tubing supplied by Dynamax for connections between the purple outlet of the 8WO and the compression fitting on the object to be measured.

NOTE:

DO NOT USE 0.12 mm ID RED TUBING FOR CONNECTION BETWEEN THE HCFM AND A PLANT SAMPLE! The red tube is used only for testing and bubble removal

3. Carefully follow the instructions in **Section 5.4**.

5.2 Valve Setting for Preparing the HCFM for Service

The valve settings are important in removing air bubbles (gas) and keeping the air from infiltrating the system at different points in the handling, use, and storage of the HCFM. During the storage of the HCFM unit make sure that the purple outlet valve is closed.

5.3 Pressurizing the HCFM

The HCFM uses a pressure bottle filled with nitrogen or air (your choice) to force water into the root, stem, or shoot. This pressure bottle can be filled to a pressure of 15 MPa (2,200 PSI). The bottle is shipped empty for safety reasons. To fill the bottle, contact your local gas distributor or physical plant. Depending on your preference or economics, the bottle can be filled with either air or nitrogen.

Gauges Specification on the regulator:

Supplying Pressure Display – 4000 PSI (Max)

Delivery Pressure Display – 1000 PSI (Max)

The bottle also has a pressure regulator that is attached to the top of the bottle using a screw clamp. Follow the directions enclosed for attaching the regulator to the bottle correctly. Use soapy water or a commercial product such as “Snoop” to check for leaks not only in the regulator-to-bottle connection, but the other hose connections as well.

WARNING!

Do not pressure the compressed air supply hose to above 690 kPa (100 PSI) while the hose is disconnected! Do not disconnect or connect the hose if the pressure is above 40 kPa (20 PSI)!

5.3.1 Tips for Setting the Pressure Regulator

The valve at the top of the bottle should not be opened until the regulator pressure set screw is backed off completely. Once this is done, open the valve on the bottle completely. Check the bottle pressure gage. The pressure should be at least 4.15 Mpa (600 PSI). This pressure is required when running a transient state flow. The minimum pressure forces enough compressed gas to the captive air tank (CAT) to keep a steady, linear pressure increase during the test. Close the tank valve, and release the hose pressure by pressing on the valve release needle.

WARNING!

Do not pressure the compressed air supply hose to above 689 kPa (100 PSI) while the hose is disconnected! Do not disconnect or connect the hose if the pressure is above 70 kPa (10 PSI)!



**Photo 1
Air Regulator Pressure**

The “disconnects” on the air pressure hose and HCFM system has a working pressure of 690 kPa (100 PSI). Pressure on the disconnect seals above 690 kPa (100 PSI) could cause a catastrophic failure of the “disconnect system” or personal injury. You also can generate a loud, annoying “pop” sound unless the pressure is released first.

Increase the air regulator pressure to 138 kPa (20 PSI) and check for leaks again. Decrease the pressure by backing off the regulator screw. Depress the end of the “disconnect” into a hard flat surface such as a coin. This will open the disconnect seal and release the small amount of gas in the hose.

5.3.2 Preparing the Compressed Air Supply System for use with the HCFM

Connect the hose quick-disconnect (Male) into the HCFM compressed air supply quick-disconnect (Female). Make sure that the needle valve is opened about 4 turns. The airflow control valve (AV) should be closed or pointed directly up. Remember that turning the valve to the right will bleed pressure from the HCFM. Turning the valve to the left will increase pressure when the compressed air supply is connected. If you are setting up to measure a quasi-steady state flow, turn the Needle Valve (NV) next to AV until the digital gage reads ~550 kPa (~80 PSI). Do not go over 550 kPa (~80 PSI). The HCFM has a safety relief valve which is set for ~650 kPa (~95 PSI).

If you wish to test the unit or run a quasi-steady state flow test, open the Compressed Air Valve until there is a steady increase in the pressure in the CAT. Fill the CAT at a rate of about 7-10 kPa (1-1.5 PSI) per second. The Needle Valve can be used to regulate the rate of increasing pressure. Close the Compressed Air Valve (AV in Photo 4 page 34) when you have reached the required pressure in a range from 200 to 500 kPa (29 to 72 PSI).



Photo 2
Compressed Air & HCFM near Connection

WARNING!
Do not attempt to adjust or “plug” the safety relief valve!

If you are doing a transient pressure test, release CAT pressure at 0 to 7 kPa (0 to 1 PSI) and turn the pressure regulator screw until the outlet pressure is at least 4.1 Mpa (600 PSI). Make sure that the needle valve is opened about 2-3 turns so that the pressure increases about 7kPa(1 PSI) per second. Open Compressed Air Valve only in conjunction to starting the software for the test. The “disconnect” on the air pressure hose and HCFM system has a working pressure of 690 kPa (100 PSI.) Pressure on the disconnect seals above 690 (100 PSI) could cause a catastrophic failure of the “disconnect system” or personal injury. You also can generate a loud, annoying “pop” sound unless the pressure is released first.

Increase the air regulator pressure to 140 kPa (20 PSI) and check for leaks again. Decrease the pressure by backing off the regulator screw. Depress the end of the “disconnect” into a hard flat surface such as a coin. This will open the disconnect seal and release the small amount of gas in the hose.

5.4 Adding De-gassed Water to the HCFM

The Captive Air Tank (CAT) is a two-compartment tank. The left compartment contains water and the right section can be pressurized with air. A flexible rubber diaphragm separates the two compartments. The large stainless steel CAT allows you to pressurize the water without the air and water mixing together. The CAT will hold 7.0 liters of water and it is best to refill while there is still at least 5.0 oz of water in the tank. If the CAT is initially empty then refer to **Subsection 5.4.2**, “*Priming a totally empty tank.*”

Normal tap water or water that has been standing naturally absorbs air. The particles in naturally found water and/or tap water plug the very small inner diameters of the tubing used in HCFM as well.

CAUTION!
Always use Distilled Degassed Water in the HCFM.

If the dissolved air effervesces, or the air comes out of solution (much in the same way a soda pop will effervesce when the can is opened), then air bubbles will form. These air bubbles will compress as the pressure increases. However, when the water is flowing from the HCFM and the pressure decreases, the air can come out of the solution. Air and water behave differently when compressed, or pressurized. Water, for the most part does not compress, with its volume changing little. Air will compress with great changes in the volume that the air occupies. That large change is why air must be removed from the HCFM system.

The water added must have the air removed. There are two accepted ways for removing the absorbed air from water. The easiest way is to “boil” the water or raise the temperature of the water to the vapor point of water 100° C (212 °F.) However boiling removes less than half the air. A more effective way is place the water in a vacuum. Degassing the distilled water is explained in **Subsection 5.4.1**, “*Making Degassed Water / Preventing Algae Buildup Inside the HCFM.*”

Your HCFM system comes with a HCFM refill kit. The refill kit is a 7.6 L (2 gallon) tank that can be pressurized by pumping air with the handle on the top of the unit. This pressurization will force the degassed water into the CAT of the HCFM when connected. The Refill Kit tank conveniently allows refilling of the HCFM just about anywhere.

There are a few important things to remember about the HCFM. The first is to always visually check the level of the degassed water in the HCFM Refill Kit. The degassed water level should never go below the siphon point inside the Refill Kit tank. If air were introduced into the HCFM system during filling, then this would mean removing the air and follow the procedures in **Section 5.5**, “*Eliminating Air from the HCFM.*”



Photo 3
Refill Kit

CAUTION!
If degassed water is kept in the refill container more than a few minutes under pressure it will become supersaturated with air again. So fill immediately after degassing!

5.4.1 Making Degassed Water / Preventing Algae Buildup Inside the HCFM

The Captive Air Tank (CAT) should be filled only with 'degassed water', i.e., water with air dissolved at less than saturating concentrations of O₂ and N₂ at atmospheric pressure. There are two methods of making degassed water. The first method is to boil water. This removes some of the absorbed gas because air is less soluble in hot water than cold water. If this method is used, the CAT could be filled while the water is still hot.

The steps for boiling the distilled water for the HCFM are:

WARNING

Take Precautions. Use Gloves when handling the Hot Degassed Water.

1. Start off with a 3.8 L (~1 gallon) of distilled water. Distilled Water is convenient and easy to obtain. It is even available in most food markets.
2. Boil the distilled water for **5 minutes**.
3. Let the distilled boiled water stand for 10-15 minutes before handling and adding the water to the refill kit.
4. Add one drop of algaecide (from the HCFM accessories kit) to the distilled water.
5. If the HCFM is new, it will be shipped empty. Repeat steps 1 through 4 so that you will have 7.6 L (2 gallons) of water to fill the CAT.
6. If the HCFM is brand new or has never been used, proceed to **Subsection 5.4.2**, "*Priming a totally empty CAT.*"

The other method is to put water into a vacuum flask and draw a vacuum over the water for 5 to 10 minutes. The steps for this procedure are:

1. Place the distilled water in a vacuum flask. Fill the flask to its logical level. Do not over fill. Distilled Water is convenient and easy to obtain. It is even available in most food markets.
2. Vacuum the distilled water for 5 minutes from the time that the water begins to effervesce with air bubbles or "boil" at room temperature. If the vacuum is really good you should see the water boil at room temperature when the pressure drops below about 4 kPa (0.6 PSI) absolute. Slowly release the vacuum to an atmospheric pressure.
3. Pour the newly degassed water into a secondary container. Repeat steps 1 and 2 until one gallon of degassed water has been produced.
4. Add one drop of algaecide (from the HCFM accessories kit) to the distilled water.
5. If the HCFM is new, it will be shipped empty. Repeat steps 1 through 4 so that you will have 7.6 L (2 gallons) of water to fill the CAT.
6. Fill the Refill Kit immediately and close the Refill Tank.
7. If the HCFM is new or been shipped, proceed to **Subsection 5.4.2**, "*Priming a Totally Empty CAT.*" The tank should be filled immediately after degassing the water by vacuum. Use the Refill Kit to insert the degassed water into the Captive Air Tank of the HCFM as quickly as possible.

5.4.2 Priming a Totally Empty Captive Air Tank (CAT)

When first priming the HCFM or if air bubbles have entered into the HCFM system, you must pre fill the CAT with at least 2 liters of degassed, distilled water before you can start the priming process. If the HCFM has had water already added, please skip this subsection and move on to **Subsection 5.4.3**, “*Adding water to a Partially Empty Captive Air Tank (CAT)*.” This pre-fill will assist in the removal of all air bubbles. Removing air bubbles as in **Section 5.5**, “*Eliminating Air from the HCFM*” is a requirement for normal operation of the HCFM. Another requirement is the removal of small microscopic bubbles that form inside the wetted areas of the HCFM and adhere to the surfaces. Note that parts of the series of instructions are very much like **Subsection 5.4.3**. That is because you must fill the HCFM unit with water to remove the air bubbles first. The steps for priming the empty HCFM CAT are:

1. Make sure that all valves are closed.
2. If there is pressure, begin to release the pressure with the Compressed Air Supply Valve. To release pressure, slowly turn the valve to the bleed air position (right).
3. Once the pressure is removed, close the Compressed Air Supply Valve.

WARNING!

Cover the “disconnect” and screwdriver with a towel to keep the hot water from spraying.

4. Raise the refill tubing straight upward. Depress the Refill Kit male “disconnect” against a hard object, such as a flat blade screwdriver, allowing the water to flow and remove bubbles from the Refill Kit tubing.

WARNING!

Take Precautions. Use Gloves when handling the HOT Degassed Water.

5. Connect the Refill Kit to the HCFM. Once the connector is snapped shut, turn the water valve to the left and proceed to using the following steps:
 - a. Make sure that there is degassed water in the Refill Kit. If not, go to **Subsection 5.4.1**, “*Making Degassed Water*.” Make sure that you have enough water to finish the sampling project in the Refill Kit, with water to spare. Some of the excess water will be used for the removal extraneous bubbles from the tubing, root compression fittings, etc.
 - b. Pump the Refill Kit with several hand strokes. This is the pressure that will force the degassed water into the HCFM.
 - c. Connect the Refill Kit to the HCFM check the tubing for air bubbles and leaks. Open the Water Supply Valve to the left to allow the water to flow into the CAT.
 - d. Pump up the Refill Kit every 1-L (0.25 gallons) with another 10-15 strokes, keeping pressure and water flow into the CAT. Note the tank pressure gage will show an increasing pressure on the compressed air supply side of the HCFM.
 - e. When the tank pressure gage reaches 15 kPa (2-3 PSI), turn the Compressed Air Supply valve to bleed the pressure from the HCFM System.
 - f. Make sure that you do not allow air from the Refill Kit tank to enter into the HCFM. Stop when you have about 1 liter (1 quart) of water left in the refill kit.

- g. Once the HCFM is filled, close the Water Supply Valve.
6. Disconnect the water connection from the Refill Kit.
 7. Pull the pressure release on the side of the Refill Tank. Lock the Refill Tank Handle by pushing down on the handle with tabs on the handle sliding into the keyed position on the top cap of the tank. Once the handle is completely down, twist the handle. The tank handle should now be locked in position.
 8. You will now need to remove any air from the HCFM system. This can be accomplished by referring to **Section 5.5**, "*Eliminating Air from the HCFM.*"

5.4.3 Adding Water to a Partly Empty Captive Air Tank (CAT)

It is important to prevent air bubbles from entering the Captive Air Tank (CAT) because these bubbles will re-saturate the degassed water. See **Section 1**, "*High Conductance Flow Meter (HCFM) Form & Function*" in this manual to learn why it is important that the water be degassed. This section assumes that the HCFM has been used (and/or filled) before. If the HCFM has not been used or air has been allowed into the HCFM Captive Air Tank (CAT), Filter, or 8 Way Manifold systems, then begin with **Subsection 5.4.2**, "*Priming a Totally Empty Captive Air Tank (CAT).*"

Follow these steps:

1. Make sure that all valves are closed.
2. Turn on the pressure gage. If there is pressure, begin to release the pressure with the Compressed Air Supply Valve. To release pressure, slowly turn the valve to the right, bleeding the air.
3. Once the pressure is removed, close the Compressed Air Supply Valve.
4. Connect the Refill Kit to the HCFM using the following steps:
 - a. Make sure that there is degassed water in the Refill Kit. If not, go to **Subsection 5.4.1**, "*Making Degassed Water Preventing Algae Buildup Inside the HCFM.*" Make sure that you have enough water to finish the sampling project in the Refill Kit, with water to spare. Some of the water will be used for the removal of extraneous bubbles from the tubing, root compression fittings, etc.
 - b. Pump the Refill Kit with ten to fifteen hand strokes. This is the pressure that will force the degassed water into the HCFM.
 - c. Raise the "disconnect" of the Refill Kit straight up and cover the "disconnect" with a towel or pads designed for hot Liquids. This will prevent hot water from spraying.
 - d. Depress the Refill Kit male disconnect against a hard object, allowing the air to flow out and remove bubbles from the Refill Kit tubing.
 - e. Connect the Refill Kit to the HCFM and check the tubing for air bubbles and leaks. Open the Water Supply Valve to the left to allow the water to flow into the CAT.
 - f. Pump up the Refill Kit every 1 L (0.25 gallon) with another 10-15 strokes, keeping pressure and water flow into the CAT. Note: the tank pressure gage will show an increasing pressure on the compressed air supply side of the HCFM.
 - g. When the gage reaches 15 kPa (2-3 PSI), turn the Compressed Air Supply valve to bleed the pressure from the HCFM System.
 - h. Make sure that you do not allow air from the Refill Kit tank to enter into the HCFM.

- i. Once the HCFM is filled, close the Water Supply Valve.
- 5. Disconnect the water connection from the Refill Kit.
- 6. Look closely for any air bubbles in the tubing lines within the HCFM unit. If you find any, refer to **Section 5.5**, “Eliminating Air from the HCFM.”
- 7. The HCFM unit should now be primed and ready to use.

Note:
THE LESS YOU MANIPULATE THE WATER AFTER DEGASSING THE LESS UNWANTED GAS YOU WILL HAVE IN THE HCFM.

5.5 Eliminating Air from the HCFM

Before eliminating air from the HCFM for the first time, study **Photo 4**, which gives the location of components on the HCFM. The labels are:

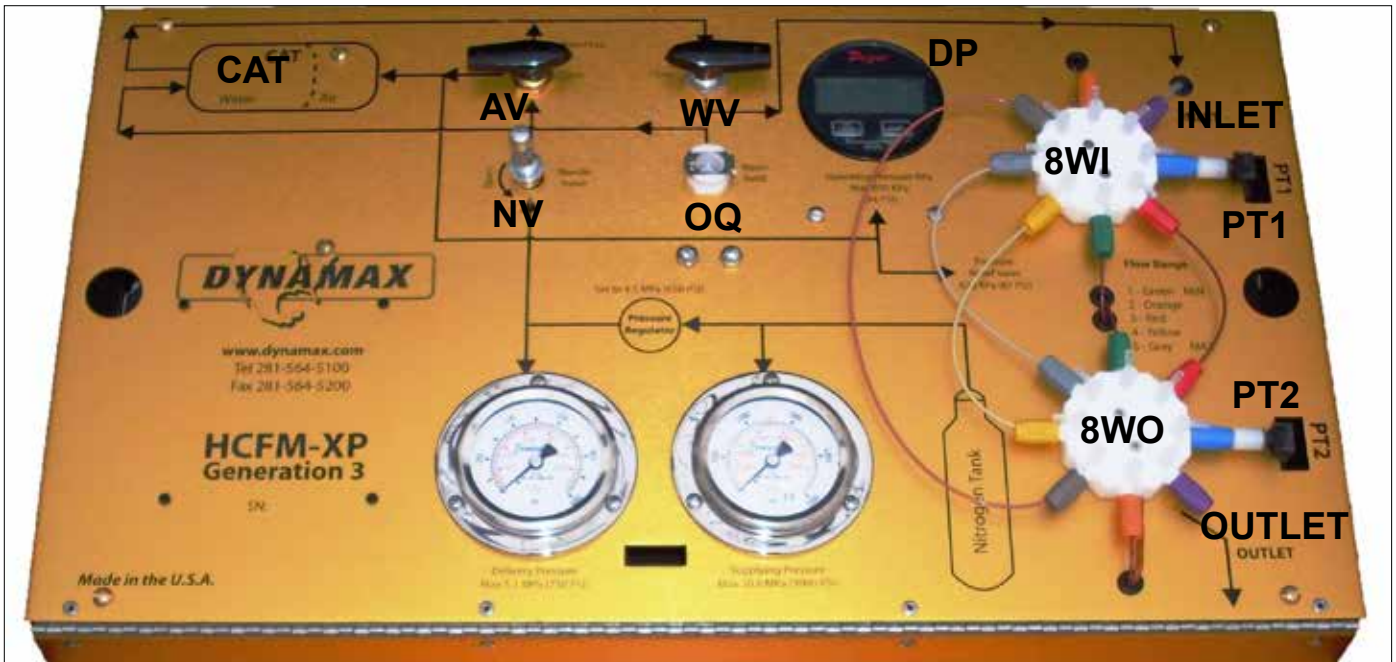

Photo 4
HCFM Components

- | | |
|--|--|
| AV = Air Valve | PT2 = Pressure Transducer #2 on outlet side |
| CAT = Captive Air Tank | PG = Pressure Gauge |
| WV = Water Valve | NV = Needle Valve |
| PR = Pressure Regulator (Not Shown) | |
| 8WI = 8-Way Inlet Manifold | 8WO = 8-Way Outlet Manifold |
| OQ = Orange quick fit connector for adding water to CAT | |
| PT1 = Pressure Transducer #1 on inlet side | |

The areas of the HCFM that require purging are all internally wetted parts. The goal is to have no air bubbles in the system. The major areas to check and purge are the CAT, the tubing, the 8-way manifold, and the HCFM Refill Kit. The HCFM can have air trapped in the CAT, the valve at the top of the CAT, and the tubing from the CAT to the filter. This can be removed quickly by:

1. Be prepared to wipe up and remove excessive water on or around the HCFM. Be sure to avoid any water entering the electronics.
2. To facilitate purging of the HCFM there is a purge valve at the top of the CAT. Apply approx. 15 kPa (2 PSI) pressure to the unit and ensures the three-way valve is closed. If a pressure greater than 15 kPa (2 PSI) is applied water will spray from the purge valve under pressure.
3. Using a rag to absorb water, slowly open the valve and allow air to escape from the purge valve. Once all the air has escaped and only water flows from the valve close it firmly.

Note:

Tilting the HCFM slightly forward so the purge valve is at the highest point can improve the performance of the valve.

4. If any air bubbles remain in the tubing, exhaust all the air from the system and open the purge valve to allow air back into the valve/tee assembly. Close the three-way valve and pressurize slightly then use the purge valve to try and remove the remaining air.
5. If visible bubbles still remain, one tip is to tilt and/or move the HCFM so that you can see the bubbles. This will also assist in moving the air bubbles from the CAT and valves to the tubing.
6. One way to remove these bubbles is to turn the HCFM unit the way the bubbles move into the water filter.
7. If you cannot move the unit, then loosen the hose clamp for tubing at the top of the CAT. Hold the tubing in place while loosening the clamp. Do not let go of the hose. Allow the removal of the air bubbles and while holding the tubing in hand, tighten the hose clamp.
8. Wipe up any excessive water off of the HCFM.

5.5.1 Purging Air from the Water Filter

Water passes from the CAT to the 0.1 m water filter (F) by way of a 12 mm ID nylon reinforced Tygon tube. If the filter is replaced, air will have to be purged from the new filter. Sometimes during shipping or because of improper filling of the CAT, some air may also enter the micro water filter that needs to be purged. All air bubbles in the filter need to be purged. A small bubble trapped in the filter will eventually dissolve, but larger bubbles must be removed by disconnecting the tubing between the outlet and the 8WI and flushing water through the system under low pressure 15 - 20 kPa (2-3 PSI). You may turn the HCFM upside down, and tap on the filter to loosen any visible bubbles, allowing bubbles to pass directly out of the INLET tube before bubbles get into the manifolds. Follow these steps in detail below:

1. Be sure the CAT has been properly filled with water and is free of air bubbles. If the CAT has been improperly filled, or there may be suspicion of air bubbles in the CAT, then follow the instructions in **Subsection 5.4, "Adding Degassed Water to the HCFM."**
2. Pressurize the CAT to 15 kPa (2 PSI) and turn the water valve (WV) from "off" to "flow" making sure the arrow is pointing to the right. This should put the water in the filter under very low pressure and low flow. Close the INLET valve on 8WI, and close the outlet valve on 8WO.



**Photo 5
Micro Water Filter**

3. Under low pressure, and using a towel to catch water drops, disconnect the water inlet tube (INLET) from the water inlet on the 8-way manifold. Then allow air and water to escape from the upper half of the filter and PVC tubing. You may need to tilt the HCFM so the water filter outlet is higher than the rest of the system. After all air and bubbles have escaped and only water flows out, replace the inlet hose and tighten the inlet coupling on the 8WI. Water should stop dribbling, once the 8WI coupling is tight.
4. Attach a clear outlet tube to the 8WO, and open the outlet valve. Then, open the flow inlet valve, the brown capillary valves, to allow any large air bubbles in the manifolds to escape. Once you observe the tube is clear of bubbles, open each capillary in turn, to remove bubbles. Proceed to 5.5.2 for more steps to clear the manifolds.

5.5.2 Removing Air Trapped in the 8-way Manifold

Small air bubbles trapped in the 8-way manifolds or in the outlet tubing can seriously degrade the performance of the HCFM during transient measurements of hydraulic conductance (Tyree et al. 1995). Air bubbles can be detected by doing a transient conductance measurement with a solid metal plug mounted in the compression fitting. See the instructions under **Section 5.6**, “*Transient Measurement of Conductance*”, to see how to perform a transient conductance measurement.

Air bubbles cause errors mostly when measuring low conductance by the transient method when using the lowest three flow ranges, i.e., the **Green**, **Orange** and **Red** ranges. The best way to remove air bubbles from the 8-Way valves is to perfuse water through the system overnight (12 hours) after bleeding the manifold. Steps for perfusing the water can be found in **Subsection 5.4.2**, “*Priming a totally Empty Captive Air Tank (CAT)*.”

The steps for bleeding the manifold are:

- a. Open or make sure to open the Water Supply Valve to the “flow” position (right).
- b. Make sure that you still have pressure by checking the pressure gage.
- c. Open the flow inlet valve. Keep all other valves closed.
- d. Loosen connector for PT1 and PT2, allowing a small amount of water to flow out.
- e. Close the Water Supply valve removing the pressure from the connection.

Each HCFM is shipped with a 5' (1.5 m) length of Red tubing about 0.005" ID. Connect the 1.5 m Red tube to the outlet tube using the smallest “Omnifit” connector part. Pressurize the CAT to about 350 – 480 kPa (50-70 PSI) and open all valves on both 8-way connectors. Allow degassed water from the CAT to flow through the system for 8-16 hours. Less than 0.5 liters of water will pass through the HCFM overnight, but that flow is usually sufficient to dissolve all air bubbles trapped in the 8-way valves and the outlet tube. In some rare cases, an air bubble may be trapped in PT2 between the 8WO and PT2. Air must be removed by carefully disconnecting Blue caps from the 8WO and injecting water using a 7/8" hypodermic needle and syringe.

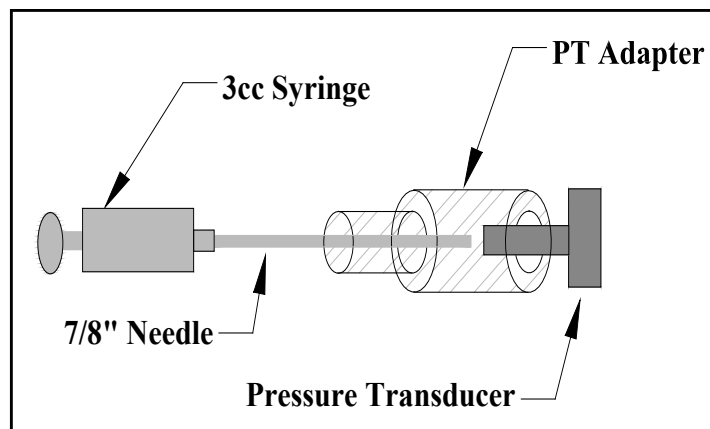

Short Needle Injection Demonstration

5.5.3 Removing Microscopic Air Bubbles from Pressure Transducers

Use the 3cc syringe and 7/8" needle we provided in the accessory kit. Fill it with Algaecide contained water. Eliminate all air bubble inside the syringe and fill the water into Transducers. Keep tapping the adapter on the transducer to move the air bubble to the opening of the Transducer then add water to push air bubble out. Make sure you **DO NOT** use the big 1 3/8" stainless steel needle on this procedure or it may damage your Pressure Transducers.

CAUTION!

Be very careful to use 7/8" needle with a dull tip and not to push it all the way to the bottom of the transducers. Failed to do so could cause damage.

5.5.4 Removing Microscopic Air Bubbles from the HCFM - Bleeding

After removing the air bubbles that you can see, we must remove the microscopic bubbles as well. Increasing the pressure and forcing water through a small orifice, or small inner diameter tubing accomplishes this. The bubbles are then either removed or are reabsorbed by the water:

- a. Increase the pressure on the HCFM with the Compressed Air Supply system to 550 kPa (80 PSI). If you have not done this or need to review this procedure, please see **Section 4.3**, "*Pressurizing the HCFM.*"
- b. Connect the 1.5 m (5 ft) Red HPLC tubing (ID 0.0127 mm / 0.0005") to the Flow- Out Port of the HCFM. Make sure that the Flow-Out Manifold is closed. You may also connect the Red HPLC tubing to the Teflon FEP hose that may already be attached to the Flow-Out valve of the Manifold. This can be accomplished with the HPLC Union included with the HCFM accessories.
- c. Open the Water Supply Control Valve to the right allowing water from the CAT to flow through the filter and to the manifold. Open all manifold valves except the Flow Outlet valve.
- d. Since there will be a small flow of water from the Red HPLC tubing, place the end of the Red tubing into a container. Open the Flow Outlet Valve on the manifold. Water should begin to flow in a very small quantity, usually a few drops a minute.
- e. As always, check for leaks. Let the HCFM flow like this for 12 hours. Check the pressure gage on a regular basis and add pressure if needed.
- f. After 12 hours close all manifold valves and the Water Supply valve.
- g. Check for small leaks again. Wipe off any excess water from the frame.
- h. Finish filling the HCFM CAT by following Subsection 5.4.3, "Adding Water to a Partly Empty Captive Air Tank (CAT)".
- i. Remove the red tubing before making measurements. Install the connecting hose (1 mm ID "Natural" or 1.5 mm ID "Clear") and bleed out bubbles before connecting to a plant coupling. Proceed to Section 9 Connecting the HCFM to Roots and Shoots.
- j. Now, you are ready to use HCFM on a plant.

5.6 Storing the HCFM

Pressurize the CAT to 140-280 kPa (20-40 PSI), shut the air valve (AV) to retain the pressure. Turn the water valve right (WV) to the “flow” position and close the outlet valve on the 8-way outlet valve (8WO). This will prevent entry of air into your system, keep a minimum pressure on connecting hoses, and your HCFM will remain in optimum form, ready for measurements, whenever you need it. Be sure to turn off the power to the HCFM A/D board and to the pressure gauge to save battery power. Also be sure to shut off the gas supply to the pressure regulator. This will prevent gas loss from your supply tank in case of a slow leak.

CAUTION!

It is recommended that you keep the HCFM pressurized at 140-280 kPa (20 - 40 PSI) with the outlet valve closed at all times when the HCFM is not in use.

- a. Open the Water Supply Valve to the “flow” position (Photo 7.)
- b. Make sure that you still have pressure by checking the pressure gage.
- c. Open the flow inlet valve. Close the outlet valve.
- d. Open at least PAIR OF VALVES, e.g. gray range valves to equalize pressure between PT1 and PT2.
- e. Keeping the system under pressure will prevent entry of unwanted air!

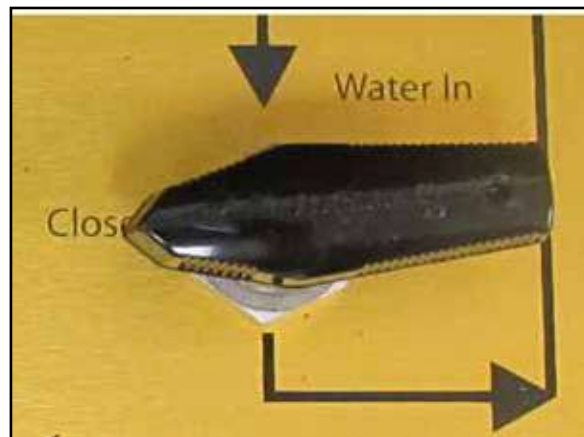

Photo 7
Water Supply Valve

6. Software Operation

6.1 System Connections

Connect the pressure regulator to the compressed gas tank you are using (usually compressed air or nitrogen). Be sure the air valve (AV) is in the "off" position. Set the supply pressure to approx. 4 MPa (600 PSI). Turn on the digital pressure gauge. If the HCFM has been previously used it should have been left pressurized to 140-280 kPa (20-40 PSI).

Locate the two 8-way valves and note how the valves are opened and closed (See figure 3). Make sure the valves to the two pressure transducers are ALWAYS left open and that the outlet valve is closed except when water flow is desired.

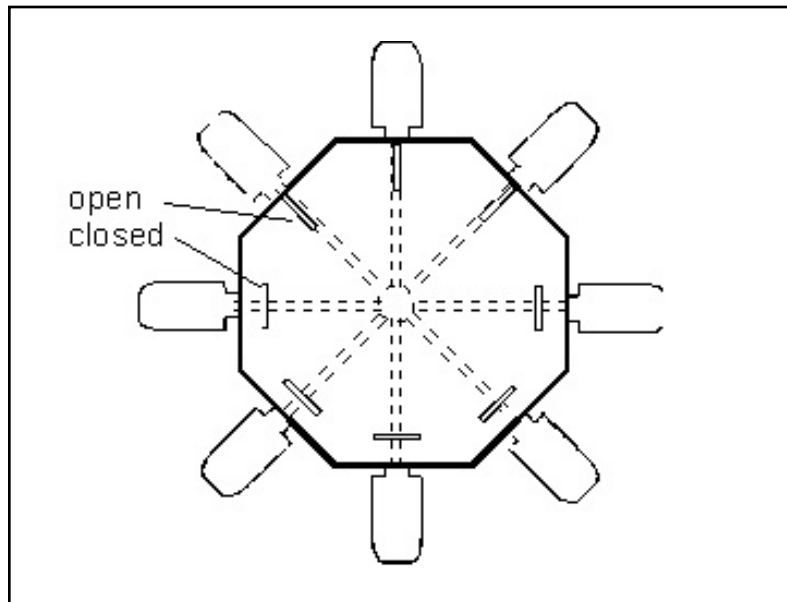

Figure 3
Manifold Openings

To pressurize the system, turn the AV to the fill position (pointing left) and adjust the needle valve (NV) so that the desired rate of pressurization is achieved (normally 0.5 to 2 PSI per second). To release pressure turn the AV to the release position (pointing right). To select a flow range (which is color-coded), open the two valves opposite the two Omnifit connectors with the same color. Make sure all other valves connected to the other capillary tubes are closed.

6.2 Opening a Project File

To collect data, we create project files, which log all data and results. The files are organized by dated folders or my documents/HCFM-Projects. Transient and Quasi-steady State data files with results are saved in comma separated files. The files contain notes, dates, and time stamped data, as well as averaged results or regression results,

1. Start HCFM software by double-clicking **HCFM** icon on the desktop. You will see a black colored status window popped up followed by a 3-second beep. Navigate to File – Open, New Project tab is selected by default.
2. Type in a Project Name (Make a note if desired.) If opening a previous project, select Existing Project tab, choose the date when project was created. Then click on **Search** button. When done, click **OK** to finish.

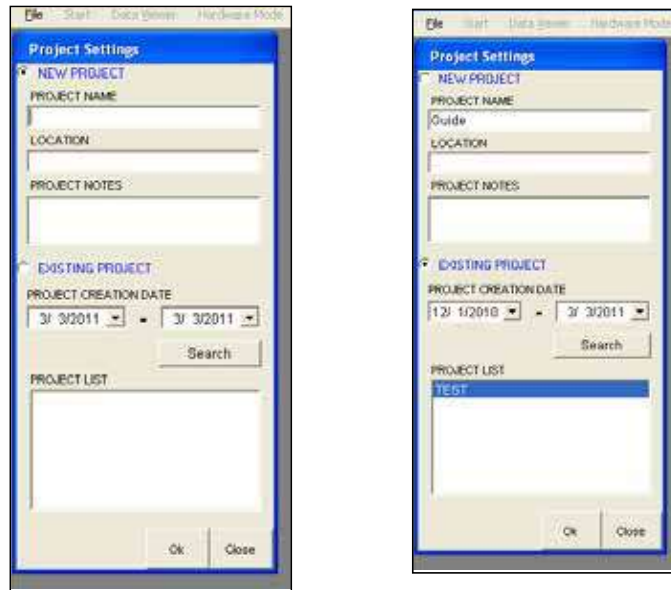

6.3 Set Zero dP- Transient Conductance Preparation

1. Choose **Set-Zero** from the Analysis Type drop down menu, then choose **Brown range** from the Set Flow Level drop down menu. Open the brown 8WI, 8WD Valves, and keep the outlet closed.
2. Click **Start** button and enter a File Name to be used for this operation. Add notes to help you distinguish among all the files.
3. Choose interval from 1 second up to 30 minutes. For a Set-Zero process, we recommend using 2-second interval. **Append Data** box, if checked, will save all data to the **file name** you entered above and any other future Set-Zero data. Otherwise, uncheck it.

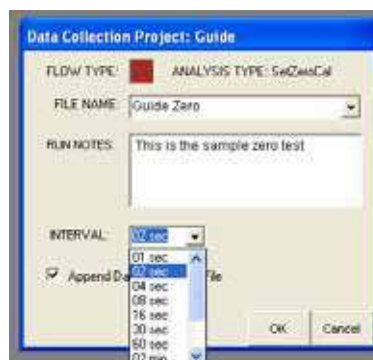

4. Make sure to completely bleed out the pressure inside HCFM CAT, and confirm that with pressure gauge reading.
5. Click **OK** to start set-zero (See the screen above.) Once hearing a beep, start increasing the pressure inside HCFM CAT by turning the air valve to **Air Flow In** position.
6. Stop pressuring at 550 kPa by turning the air valve to **Closed** position.
7. If there is any unsatisfactory data collected, you can check **Set Ignore Points** box and high light those points (shown in dark color.) You can also remove these highlighted points a, b, c, d, by clicking on **DEL** button. Normally a 1st order regression will remove dP offsets across the range of a transient data sets.

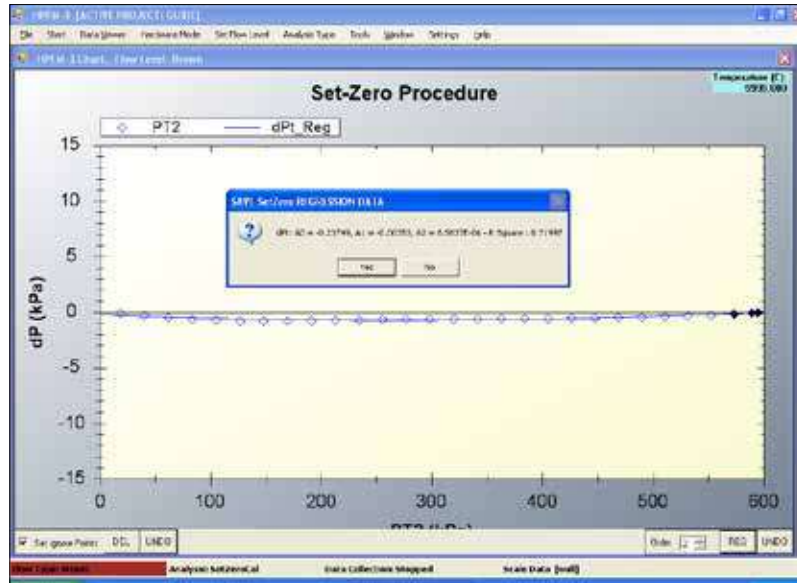

- a. To Ignore points check the **Set Ignore Points** Box in the bottom left hand corner, and then select the points you want to ignore.
 - b. To delete points, select the points you want to delete and click **DEL**.
 - c. To retrieve deleted points click on the **UNDO** button in the bottom right hand corner.
 - d. To undo the regression select the **UNDO** button in the bottom left hand corner
8. You may increase **Order** to 2 and click on **REG** button to perform a regression. A new window will pop up to indicate the regression result. Click **Yes** to save it.
 9. Saved set-zero results applied to all subsequent transient dP calculations. Removing drift or temperature changes to the pressure sensor readings. Set-zero regressions can be seen in the data viewer.

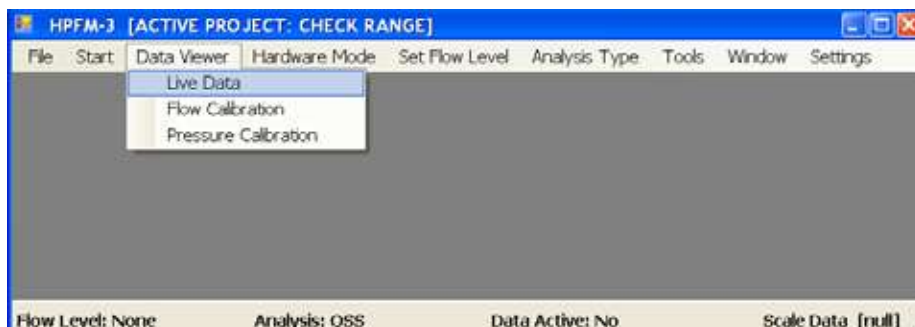

6.4 Transient Measurement of Conductance

Introduction

The transient measurement of conductance of your root or shoot sample allows a quick and fast way to gather the data either in the field or the lab. Quickly acquiring the data is good when dealing with the root systems especially. The root systems as well as the shoots of many plant species have the ability to “repair” themselves and plug off the xylem. Also, there is an osmotic effect in root systems that will increase the osmotic pressure (and therefore reduce the flow) as more water is injected into the root system.

6.4.1 Measurement of the Transient

The “Transient” option is used to measure root or shoot conductance dynamically, by measuring flow every few seconds while allowing the applied pressure to change at a constant rate of 5 to 10 kPa s⁻¹ = (0.5 to 2 PSI s⁻¹). When measuring low conductance on the lowest flow ranges (Green and Orange) it is especially important to do prior transient measurements while the HCFM is connected to a solid metal or plastic rod the same diameter as the object you will measure. See **Section 3**, “*Applications and Theory of Operation*” to understand what the data will look like when air bubbles are present. Follow the instructions under **Sub Section 5.5** (“*Eliminating air from the HCFM*” to solve the problem.”)

1. Adjust the needle valve so that the rate of pressurization is at the desired rate approx.between 5 to 10 kPa (0.5 to 2 PSI) per second when the AV is in the pressurize position. Then reduce the pressure to < 7 kPa (1PSI) by moving AV to the release position. Then open the outlet valve and allow water to flow out of the compression fitting with the Yellow range selected. Insert the object to be measured while water is flowing to reduce the chance of trapping an air bubble.
2. Select the desired range and lower the pressure to < 7 kPa (1 PSI). The time interval can also be selected in a drop-down box but the default value of 2s is good for most purposes.
3. Select Transient as Analysis Type and estimate a colored flow range and choose it from Set Flow Level menu.

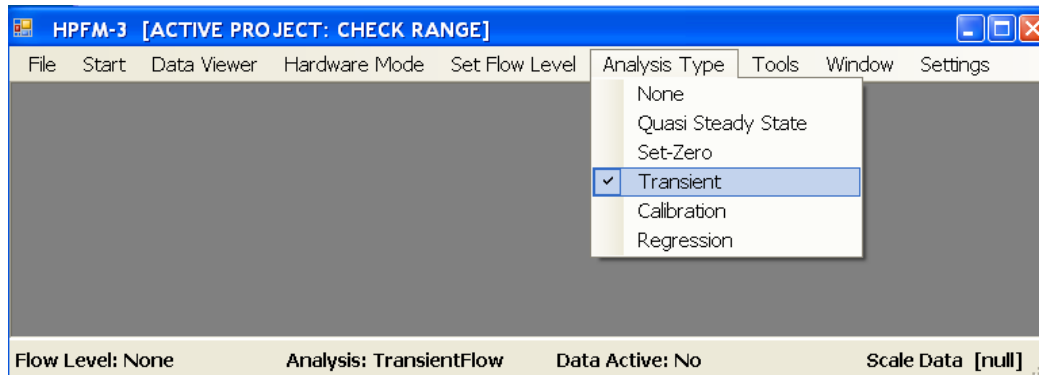

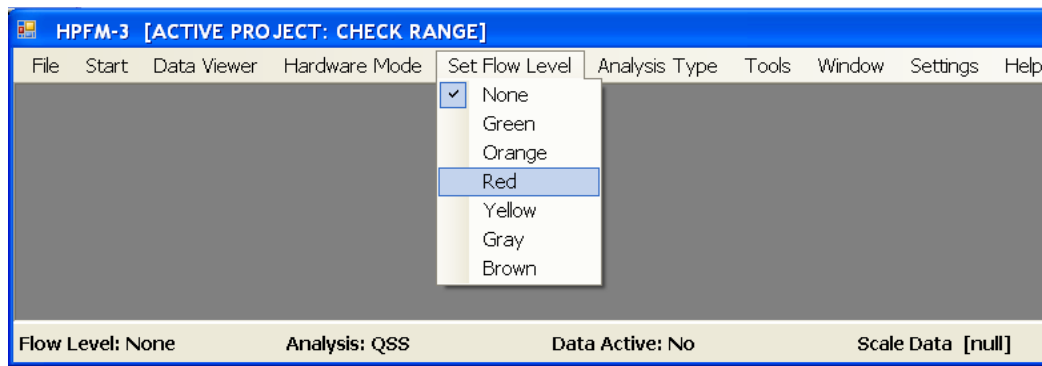

4. Enter a **FILE NAME** and comments, select **INTERVAL** and click **OK** button.

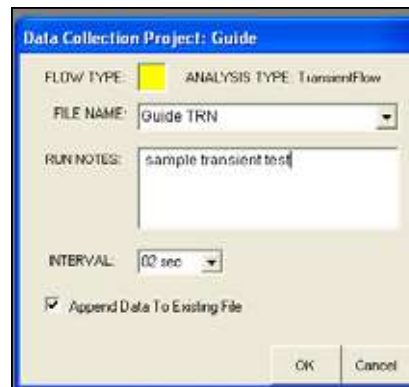

5. Confirm HCFM CAT pressure at 0 kPa according to pressure gauge. Click **Start** and a new window will pop up. Enter a **FILE NAME** and comments, select **INTERVAL** and click **OK** button. Once you have selected a file name data collection will automatically begin. As soon as the first points appears on the graph start the pressurization.

Start the flow of air into the CAT at the rate of 5 to 10 KPa per second, as adjusted earlier with the needle valve. Open AV to let the pressure increase.

Observe the **LIVE DATA** viewer and dials for the tank water pressure, for approaching the maximum pressure. Observe the flow rate % dial, to see if you are exceeding the calibration range.

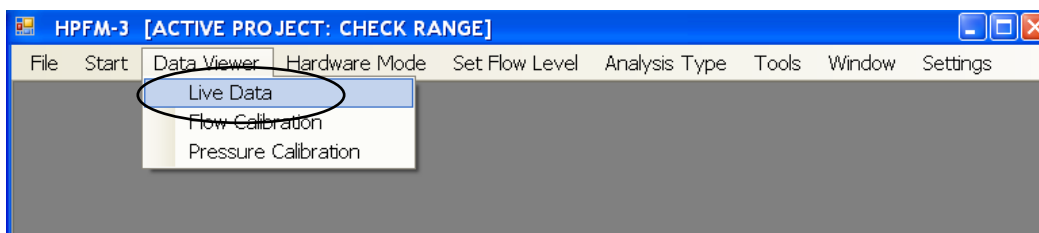

WARNING!
Always proceed with the transient measurement as quickly as safety and sound research practices will allow.

5. Continue pressurization until PT2 reaches about 500 to 550 kPa or sooner if you detect a problem, e.g., wrong range selected or a leak observed.

Towards the end of the test, try to stay between 50% and 100% of the flow rate of the range. In the **RED RANGE** case shown here, dP and flow rate exceed the limits, and one must choose the next higher conductance flow range.

6. Stop pressurization by turning the AV to the off position. Click the **STOP** tab, to finish capturing data for this transient.

If you wish, you may continue recording values after the pressurization stops, but it is not recommended when measuring roots since continual flow of water changes the root properties. An example of a typical graphical curve at the end of a transient is shown in **Figure 7**.

7. If you are measuring a root, quickly release the pressure so as not to change the root by continued perfusion. Often the first transient is poorly shaped because of air bubbles or leaks or because the rubber in the compression fitting is shifting position. So you will probably want to do one or two more transients on the same object.

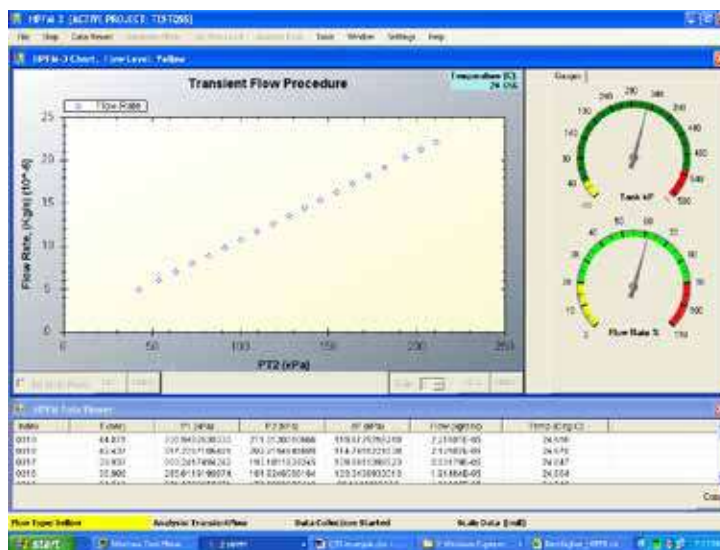
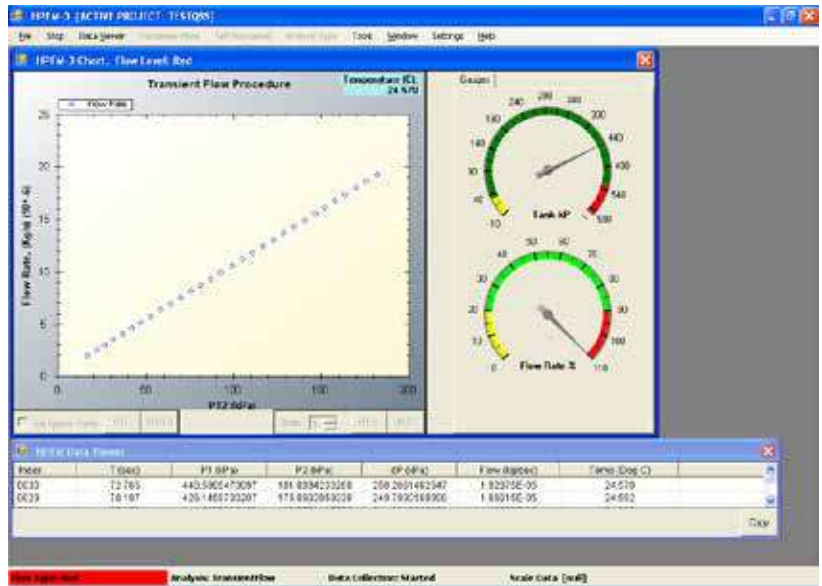

WARNING!

If releasing the pressure quickly causes air to effervesce, this indicates that air in the CAT tank is supersaturated with air. Immediately refill the tank with degassed water to avoid this problem!

Note:

If the wrong range was selected, you will hear a beep in the beginning of the measurement, and a small window will pop up asking you to select next lower or higher range. Click Stop, change the capillary selector, choose range from Set Flow Level menu, and click Start again.

6.4.2 Regression of the Transient, Current Data

After stop, check **Set Ignore Points** box and select points to be ignored or deleted. Usually you will ignore points below 100 kPa.

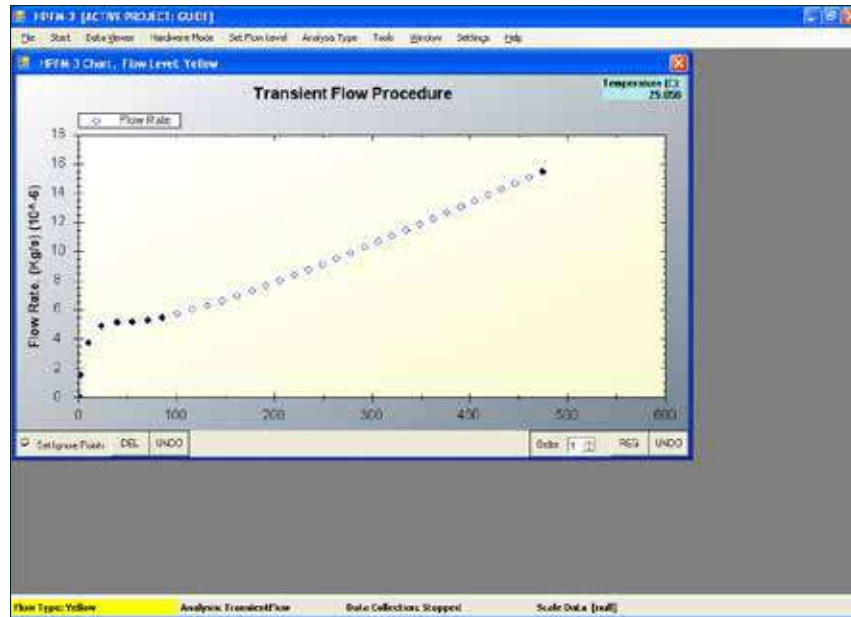

6. Apply 1st order regression, and click **Yes** to save regression values.

Note:

All regression temperature corrected K and standard temperature (25°C) K are saved in the file named by the project managers with a .trn extension. See Sections 7.1-7.4 for more information.

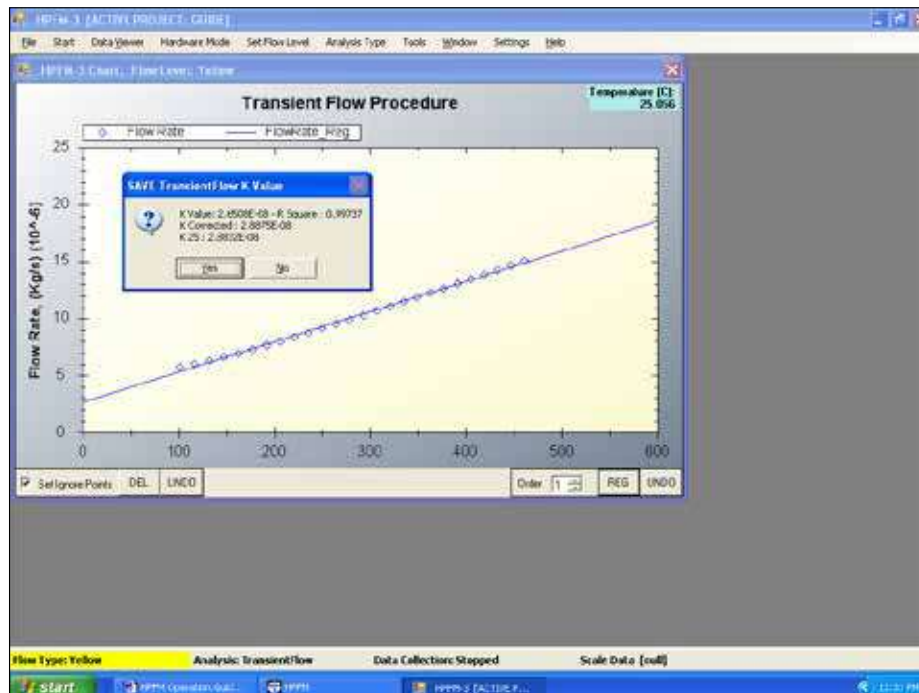

6.5 Regression of the Transient, Saved Data (.trn) Files

At any time later, recorded files can be retrieved and analyzed. While measurement of the Transient is simply graphing a line of increasing pressure and flow, Regression provides the “best fit” of that graphical line and calculating the slope. That slope is the hydraulic conductance of the measured plant.

Choose **Regression** as the **Analysis Type**. Click **Start** and **Regression** window appears.

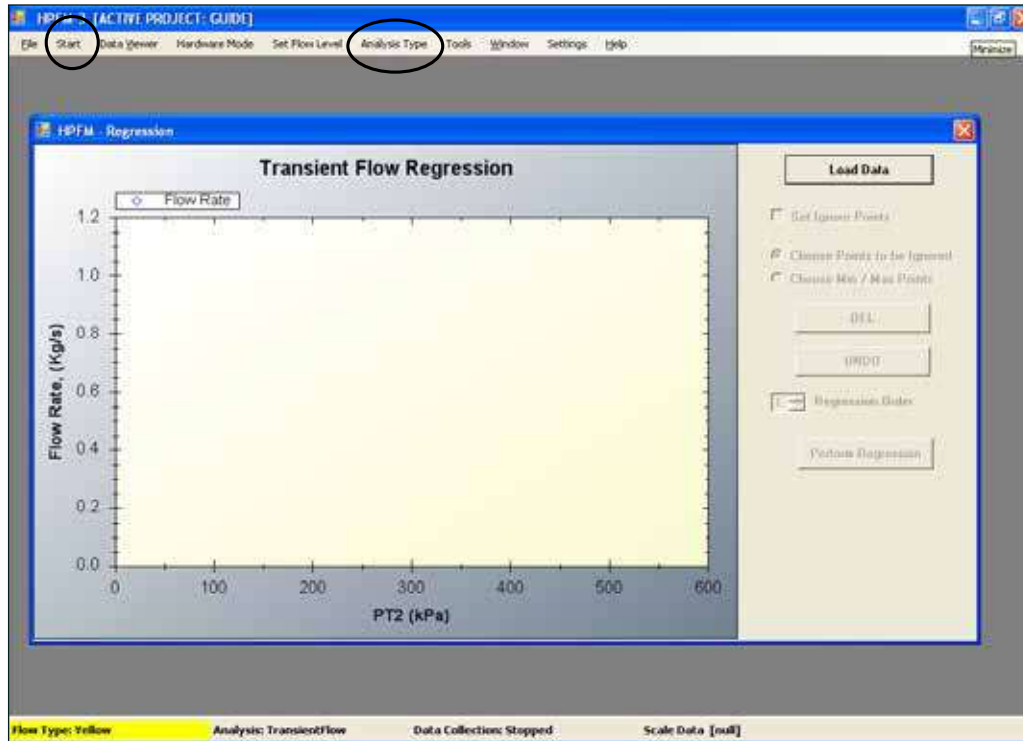

Click **Load Data**, navigate to the desired folder, and choose your transient data to be analyzed. Check **Set Ignore Points** box and select **Choose Points to be Ignored**. Usually you should ignore all points below 100 kPa, and points not fitting a straight line. You may click and drag over chart areas to blow up the chart to reveal more detail.

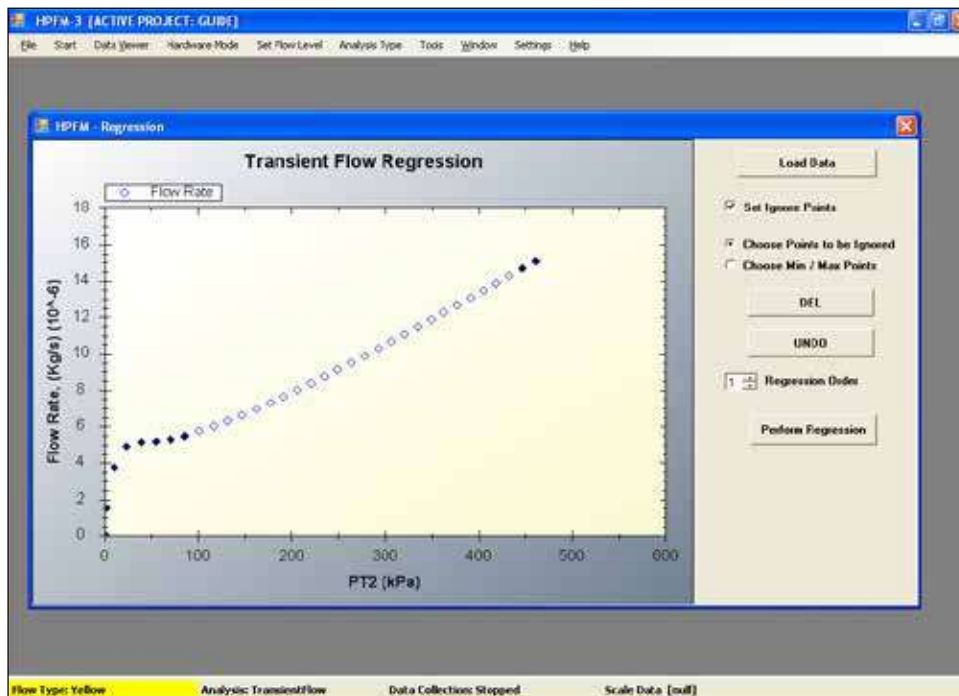

Or select **Choose Min / Max Points** instead.

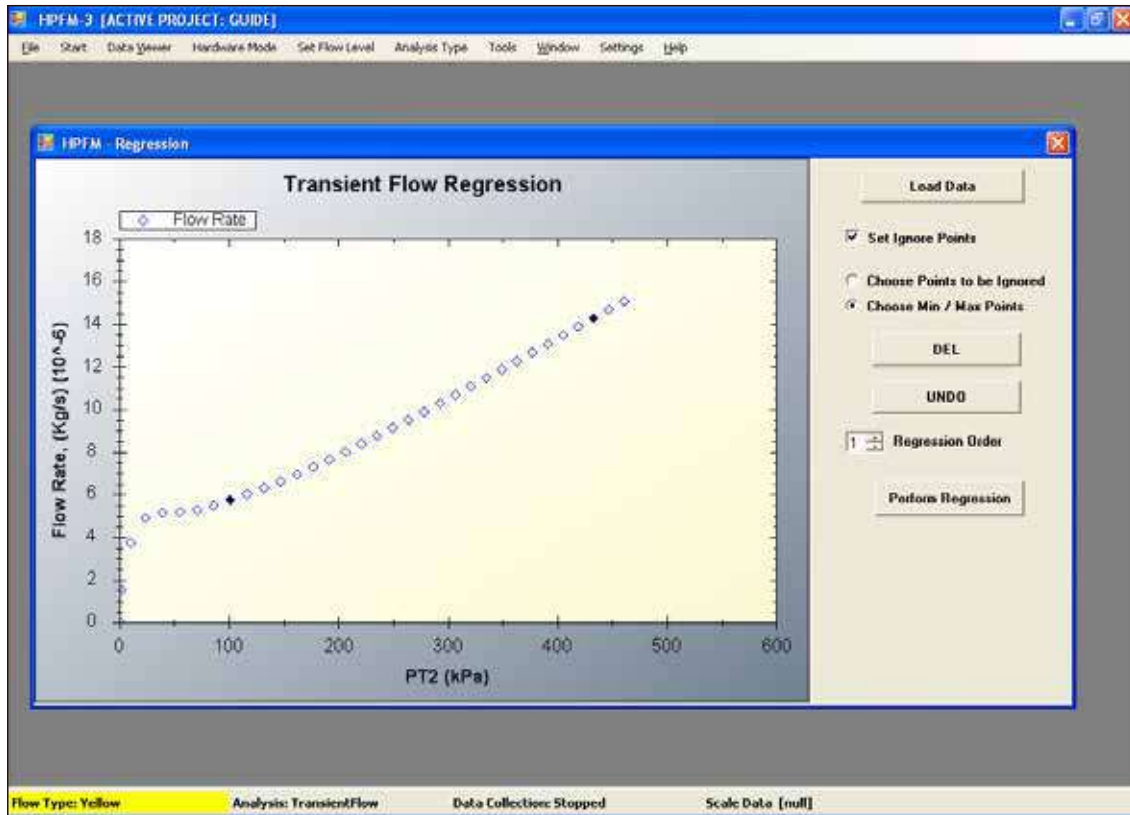

Choose 1st **Regression Order**, and click **Perform Regression** button to finish. Click **Yes** to save the regression.

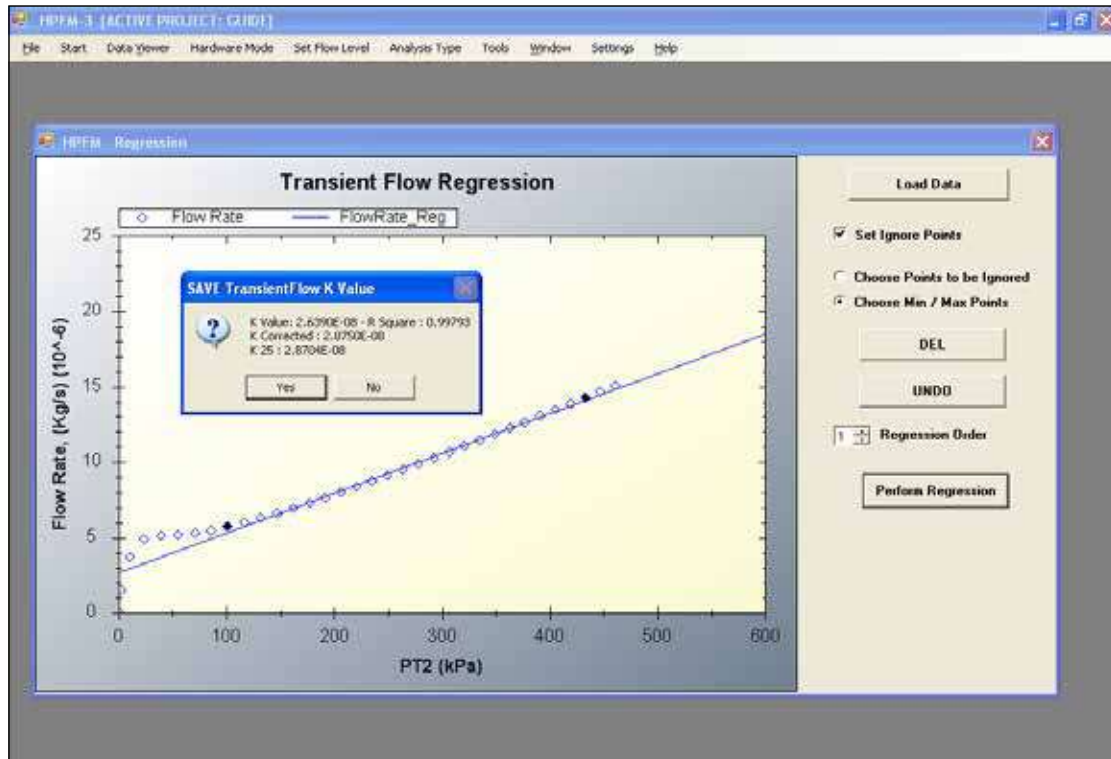

6.6 Introduction QSS- Quasi Steady State

Quasi Steady State measurements and results depend on nearly steady pressure from the water supply as well as an outlet pressure that closely matches the pressure at the sample. A difference in pressure caused by raising the sample above the outlet reduces flow, and similarly lowering the sample increases the flow due to the weight of water in the attachment hose affecting the pressure. Try keeping the sample close to the same level as the instrument outlet P2 transducer. An HP offset is available in QSS measurements to remove this pressure difference, if so desired. In contrast to transient measurements, a constant offset is already removed by the regression, since the slope (K) accounts for the difference in flow divided by the difference in pressure. In QSS measurements we need to be more careful to avoid creating more or less conductance from the dP offset.

Small variability in readings is removed by allowing a QSS measurement to stabilize, and then use the **AVERAGE** button, to store the running average of 10 most recent readings.

6.6.1 Getting Started with QSS

Before you start, make sure that you have zeroed the pressure transducers according to **Section 6.3**, “Set Zero dP- Transient Conductance Preparation”. Setting the zero flow volts must be done at the start of each daily usage of the HCFM. Make sure that you are correctly connected to the sample in **Section 7**, “Connecting the HCFM to Roots and Shoots.” To check the flow range, setup for a quasi-state flow:

1. Check the pressure gage for the desired flow pressure. Make sure that the Compressed Air Valve is in the off position (straight up) and the Water Valve is positioned to allow water flow into the filter and Subsequently into the valve manifold (8WI and 8WO) system. The valve should point toward the right, parallel to the hose.
2. If you have sampled a root system of the type and species that you will be testing, set the HCFM to the desired flow range by closing off 8WI and 8WO valves on all ranges.

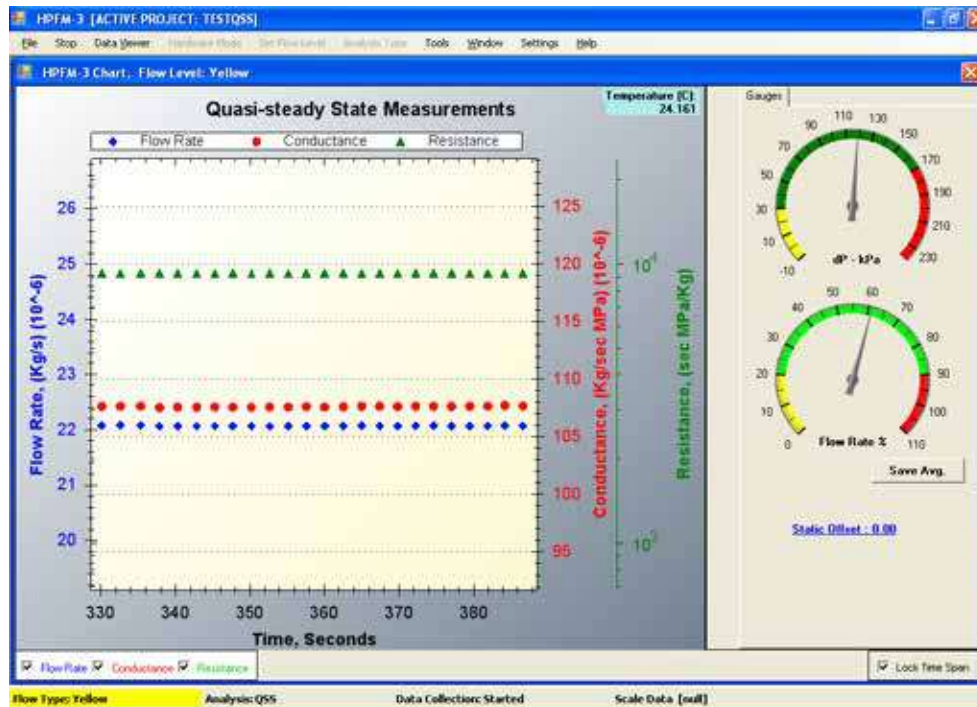

- a. Start the HCFM software and follow the direction of **“Quasi-State Flow Measurement”**, using the “QSS” function from the “Analysis type” menu.

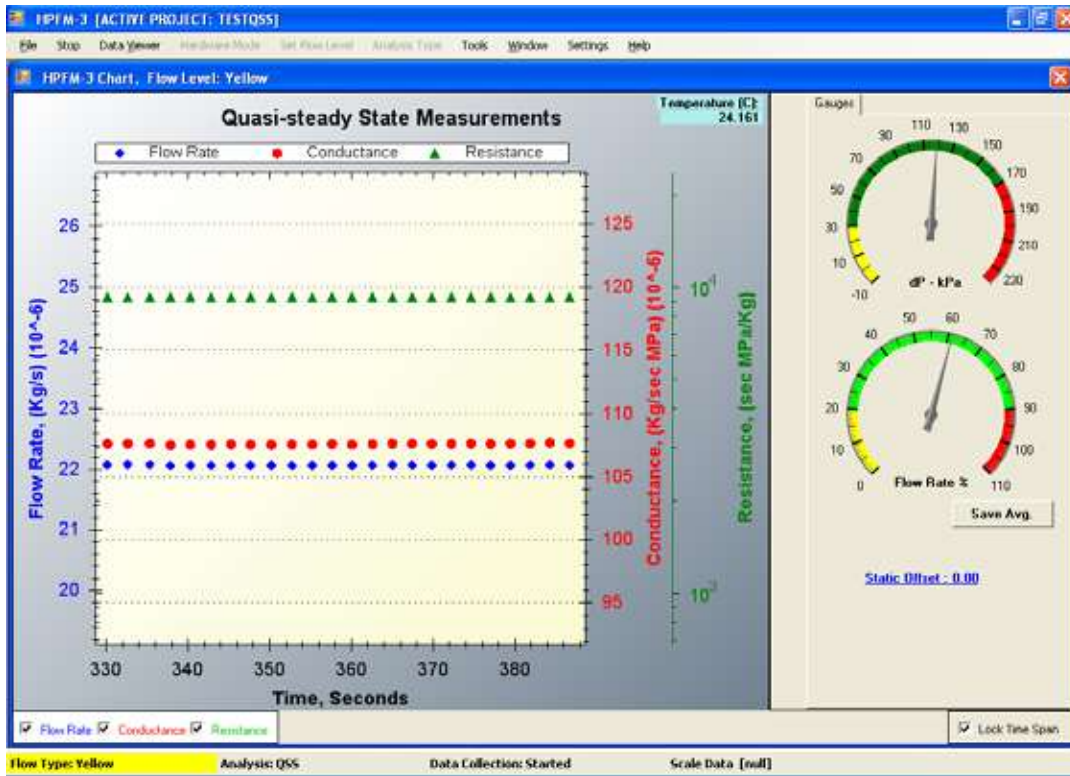

b. Click on the **STATIC OFFSET**, set the new value to zero, and **SAVE**

The screenshot shows a dialog box titled "HP Offset". It contains the following text and controls:

- Current Value : 9.00
- New Value :
- Buttons: Save, Cancel

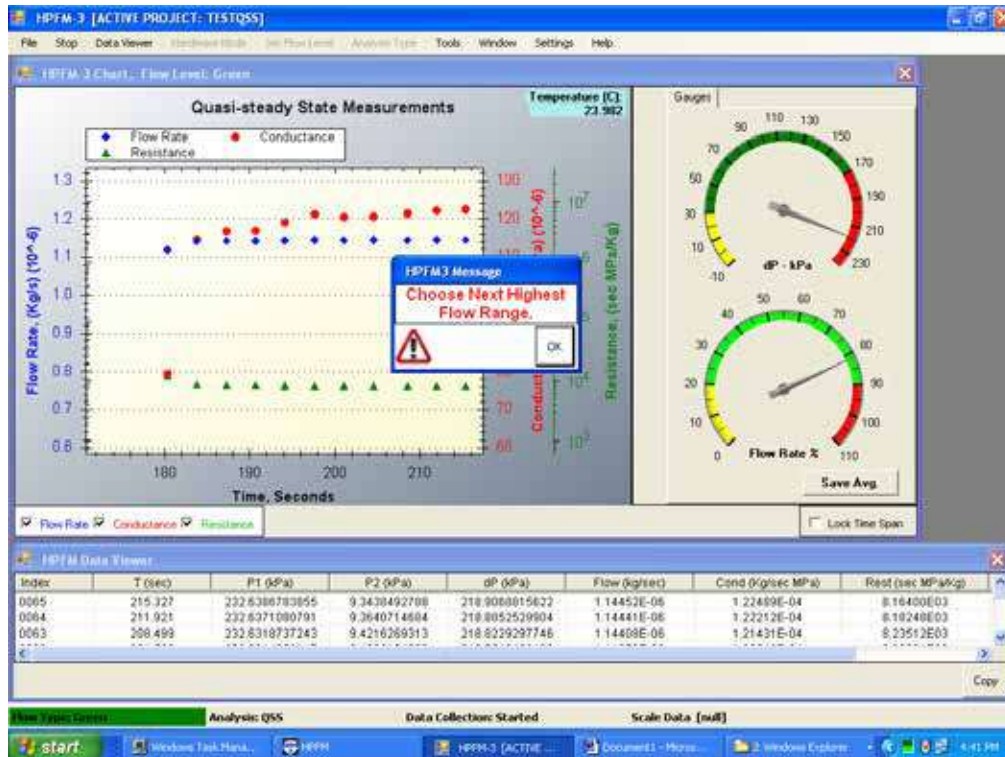

- c. Open all two valves corresponding to the desired range and open the flow out valve. Check for leaks in the lines. Select yellow, for example, and set the pressure to about 300 kPa. Click **START** and proceed with readings.

If the software recognizes that the differential pressure between PT1 and PT2 is over 180 kPa, then it will give you a message telling you that the dP is out of range. You will need to go the next highest flow range. The following steps accomplish this:

- d. On the computer running the HCFM software select the **“STOP”** button.
- e. Open up the valves on the manifold for the next highest range. For example, if you are on the GREEN range and need to go to the next highest range, which would be the Orange range. So you would open the valves corresponding to the Orange colored HPLC caps.
- f. Returning to the software click on the Orange flow level range and click the **“Start”** button. You should see a decrease in the differential pressure and the software will stop warning you of an excessively high differential pressure.
3. The working range for the differential pressure is 20 to 180 kPa. If you attempt to measure dP values above 180 kPa you will be beyond the calibration range. If you are below 20 kPa (3 PSI) your readings will be more accurate on the next lower flow range.

Note: When you are working with root systems, the differential pressure will normally decrease the longer you have the HCFM coupled to the root. The range should be set accordingly.

CAUTION!
The desired working range for the differential pressure (dP)
is 30 to 180 kPa.

4. If the flow rate is too low for a given range, the dP is too low as well. In the graphic example of the GREY range below, note the two dials showing dP and Flow rate are in the yellow warning area. Note the data is also erratic as demonstrated by raising the sample by 30 CM and then lowering the sample. The dP difference caused by gravity on the water tubing causes a significant fluctuation in K.

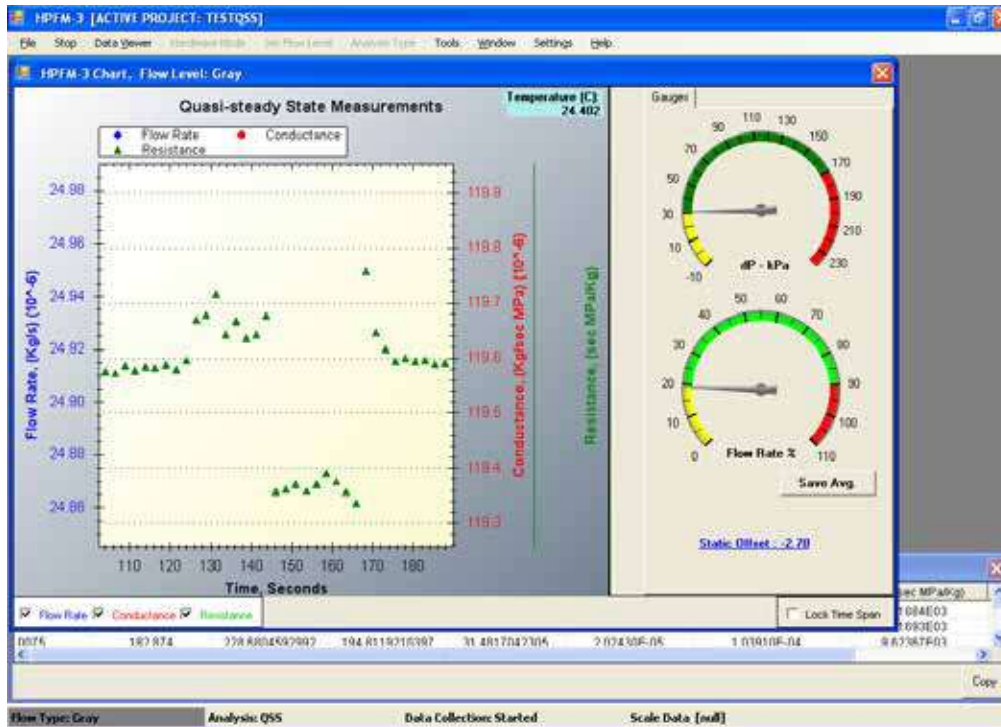

a. On the QSS Control software select the **“STOP”** button

For best results, apply a dP pressure between 90 and 150 kPa. You may increase the pressure at the CAT to force more water flow within a given flow range, if desired.

5. Setting the STATIC OFFSET

Static offset will occur electronic drift in the PT1 and PT2, and as mentioned in the QSS introduction a difference in the sample height can also introduce an offset. The electronic offset can be removed by closing the outlet, and reading the dP in the DATA VIEWER. An offset at the sample can be removed by inserting a solid plug at the sample connection, and leaving the outlet open.

Here is an example. Check the zero flow for this range (RED) under static conditions. Close the outlet or block the connector to the sample. Find the dP at zero flow in the data viewer. Make an offset correction. If the dP is positive, enter a negative value for the offset correction. Open the outlet to take corrected values.

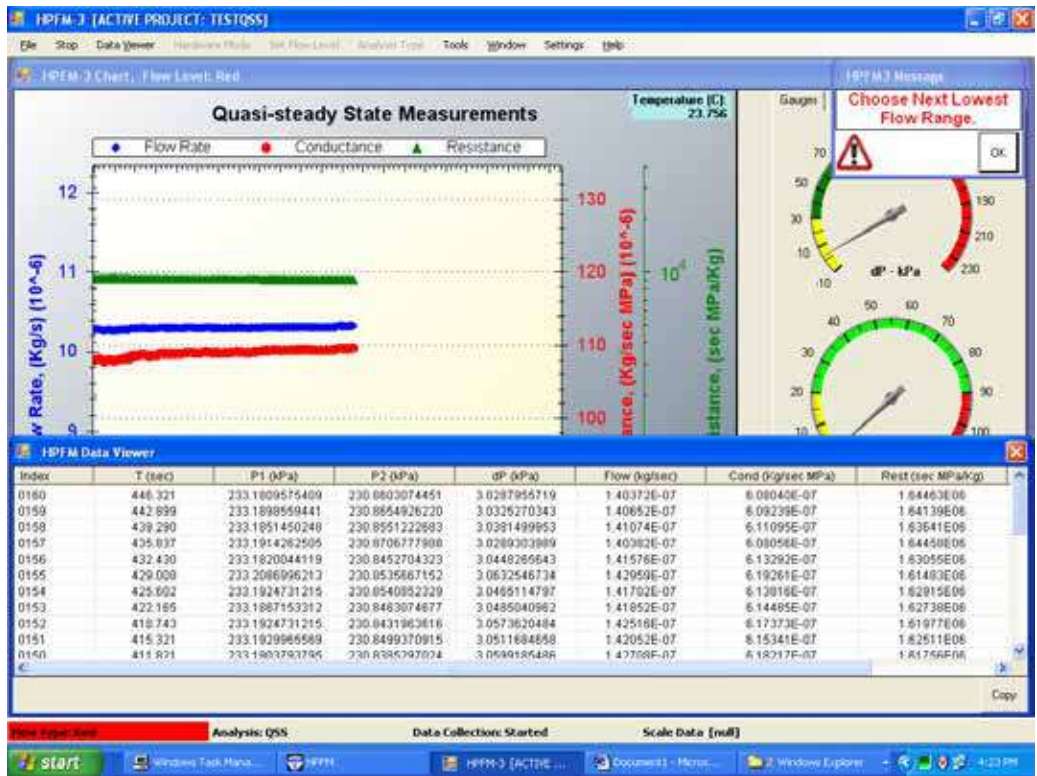

In this example we entered a static offset of -3.02 .

After starting again, we note the dP is less than 1, and calculated zero flow in the data viewer. Static offset is saved in the HCFM.INI file, and will be used for the next time HCFM is turned on, or the flow analysis (QSS only) is restarted. If one changes to a new flow range, be sure to check or change the Static Offset.

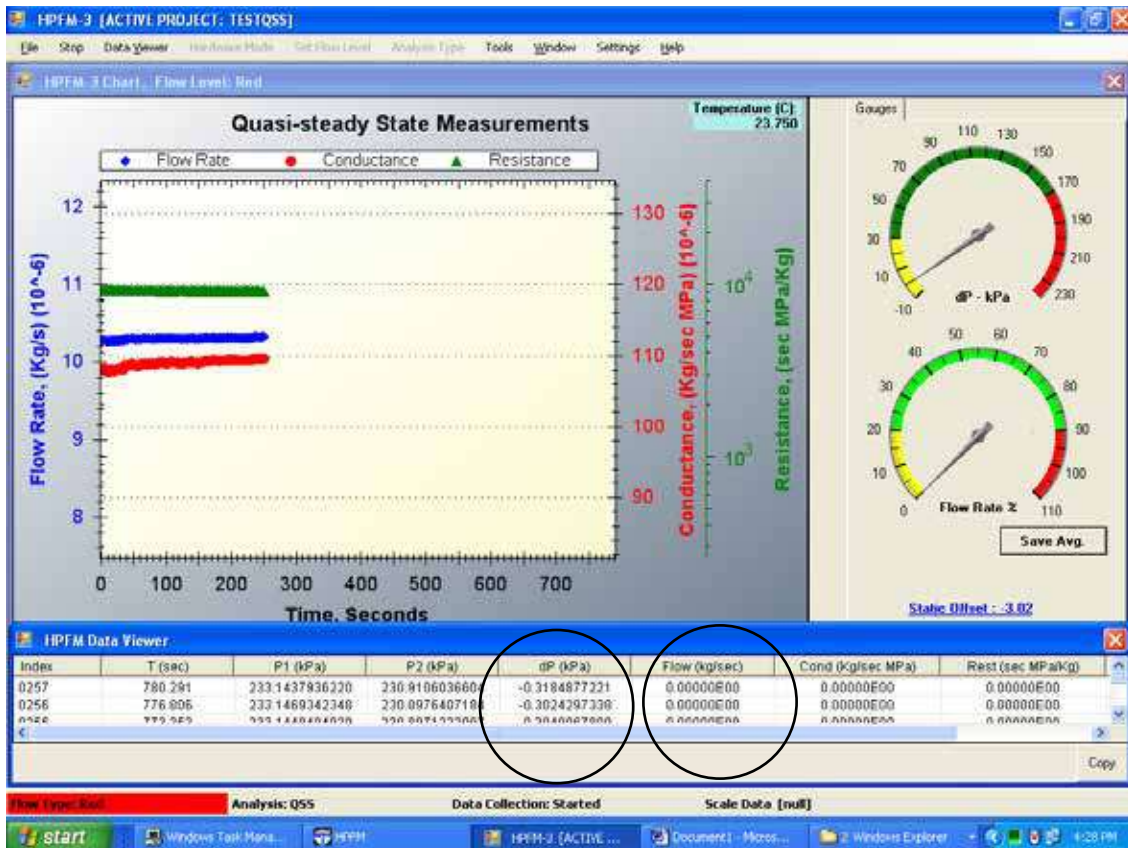

6.7 Graphics Operation

One of the best new HCFM feature are the graphics, and interactive operation available to Zoom, Unzoom, Print and view real time data. One may lock the time span, to see only the recent data.

At any time on any operation type, right click on the graphic window to bring up the menu.

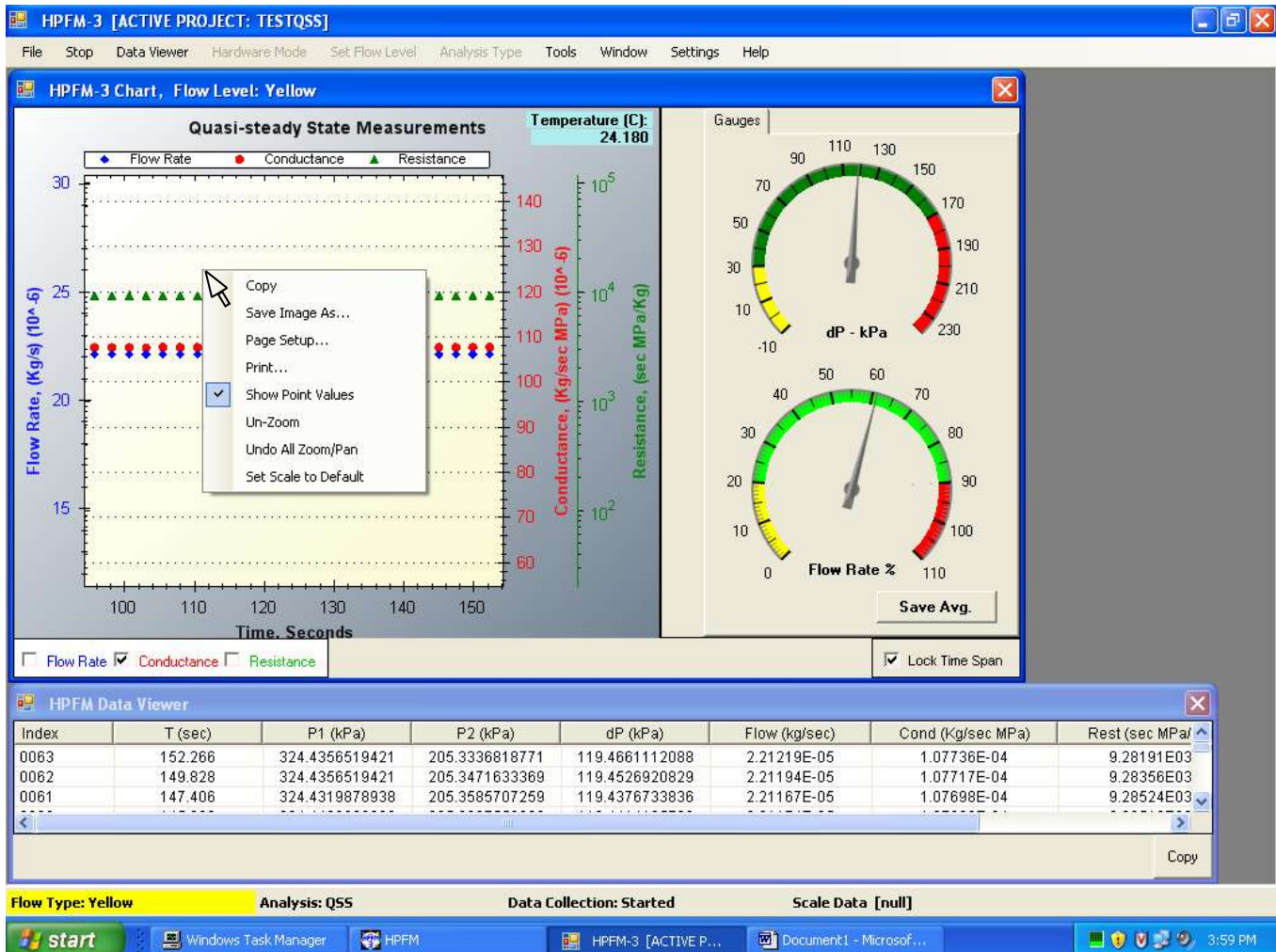

To zoom in on a series of data, point above and left of a part of the graph you want to enlarge, and drag your pointer to a point below and to the right. When you let go of the clicker, the view inside that box will expand.

Zooming can be done by moving a scroll button either up or down, for Zoom in or Zoom out.

Checking on the **SHOW POINT VALUES**, allows one to hover over a graphic data point and see the exact values numerically.

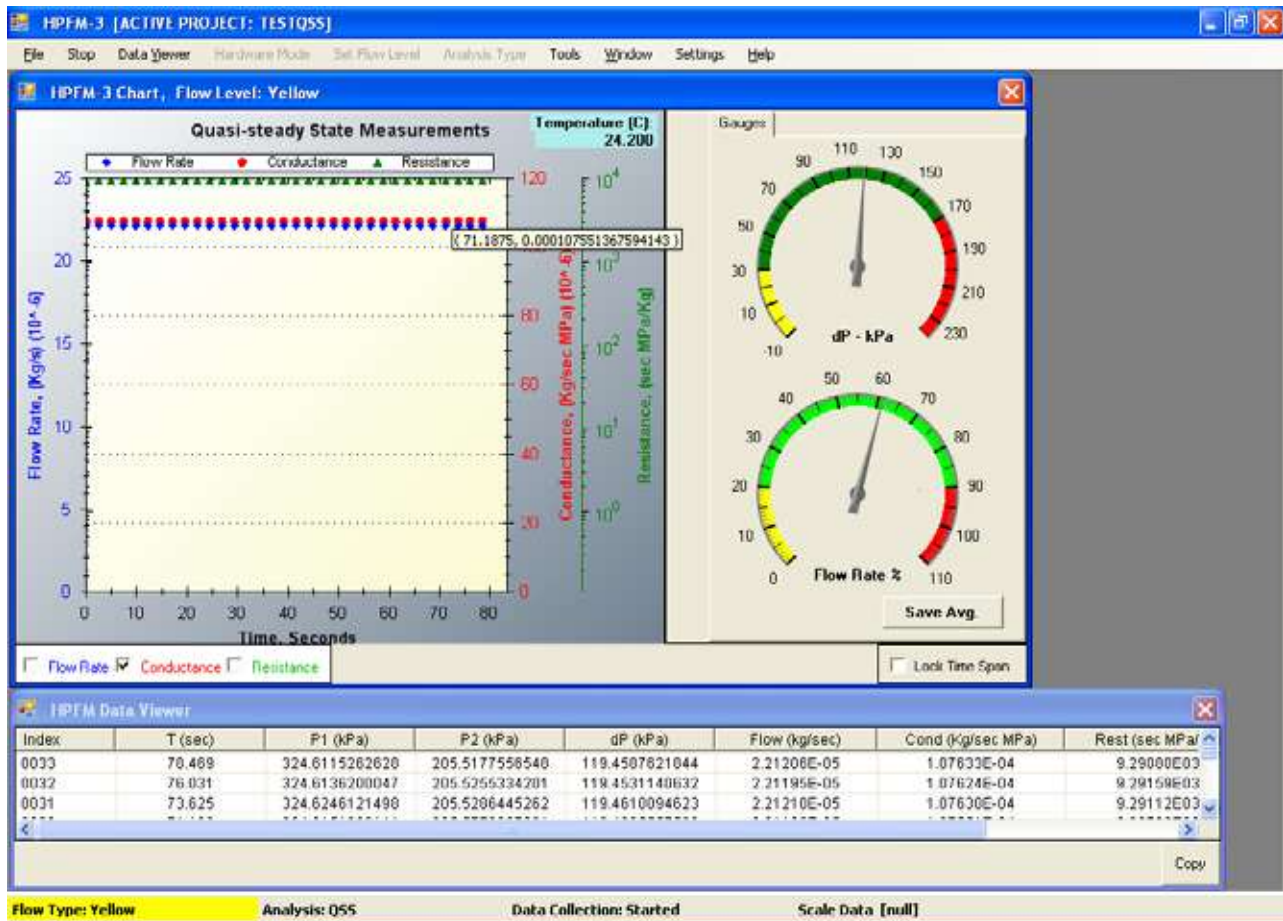

To unzoom, it is easier to click the Unzoom, or set scale to default. The default is the normal pressure range of HCFM.

Images are saved whenever you right click, and select **Save Image As...** This action will allow you to save images in six common image formats.

7.0 Raw Data for K, and Temperature Corrections

7.1 Temperature Corrections with the Built in Sensor

The calibration factors used to convert dP to flow are temperature dependent, because KCT is inversely proportional to the viscosity of water and the viscosity of water changes about 2.3% per oC (Tyree et al 1995). The HCFM will be supplied with calibration curves and the temperature at which the calibration was done.

During lab measurements the HCFM and sample are often at nearly the same temperature, but in the field the HCFM and sample can be at different temperatures, e.g. 5 to 10 oC different, if one is in the sun and the other is in the shade. The best practice is to keep both the HCFM and sample shaded to ensure similar temperatures. If the sample is wet, the evaporation can also lower the temperature below the air temperature.

7.2 Corrections At Test Temperature

HCFM Gen 3 has a built in sensor attached to the outlet manifold, which records and logs temperature with all the flow and pressure data during calibration. The data collected with all measurements are recorded in real time always. The conductance values are adjusted by the following formula:

$$K_{corrected} = K (0.554 + 0.0225 T)/(0.554 + 0.0225 T^*)$$

Where:

K = the uncorrected conductance,

T = the temperature at which K was measured, and

T* is the temperature at which the HCFM was calibrated. The resistances could be corrected as well by the user. by the following formula:

$$R_{corrected} = R (0.554 + 0.0225 T^*)/(0.554 + 0.0225 T)$$

Shown below is the example of the K, K corrected and the K25 calculated conductance results from a QSS reading.

Index	T (sec)	dT (sec)	P1 (kPa)	P2 (kPa)	dPaz (kPa)	Flow (kg/s)	Cond (Kg)	Rest (sec)	Temp (Deg C)	
110	107	248.042	2.338	242.2851	148.2381	93.35355	1.73E-06	1.17E-05	85536.79	23.64
111	108	250.385	2.343	242.294	148.2366	93.36399	1.73E-06	1.17E-05	85526.2	23.665
112	109	252.724	2.339	242.2835	148.2164	93.37358	1.73E-06	1.17E-05	85505.62	23.651
113	110	255.063	2.339	242.284	148.2184	93.37205	1.73E-06	1.17E-05	85508.25	23.647
114	111	257.403	2.339	242.2809	148.1982	93.38097	1.73E-06	1.17E-05	85480.88	23.673
115	112	259.742	2.339	242.284	148.2055	93.38491	1.73E-06	1.17E-05	85488.83	23.666
116	113	262.083	2.341	242.294	148.1827	93.41748	1.73E-06	1.17E-05	85445.46	23.672
117	114	264.422	2.339	242.2804	148.1469	93.43936	1.73E-06	1.17E-05	85404.56	23.643
118	115	266.779	2.357	242.2668	148.149	93.4237	1.73E-06	1.17E-05	85420.27	23.659
119	116	269.12	2.34	242.2877	148.1526	93.44103	1.73E-06	1.17E-05	85406.3	23.663
120	117	271.459	2.339	242.262	148.1557	93.4123	1.73E-06	1.17E-05	85434.72	23.687
121	118	273.799	2.34	242.272	148.1718	93.4063	1.73E-06	1.17E-05	85449.55	23.658
122	119	276.139	2.34	242.2704	148.1516	93.42479	1.73E-06	1.17E-05	85420.75	23.664
129	AVERAGE:						1.73E-06	1.17E-05	85445.96	23.66301
130	AVERAGE:						1.73E-06	1.17E-05	85436.33	23.66409
131	K Corrected:							1.19E-05		
132	K 25:							1.23E-05		

The formulas above correct K- and R-values to the temperature at which the sample was measured.

7.3 Raw data tables, project data

Users who want to make temperature corrections should measure the temperature dependence of their study species for the sake of maximum accuracy. Fortunately, in many cases the two temperature corrections cancel out if the following conditions hold: (1) The temperature dependence of the capillary tubes on the HCFM and of the sample are equal. (2) The HCFM and the sample are at the equal temperature, even though the temperatures might differ between measurements.

7.4 K25 - Conductance At Standard Temperature

In the case of temperature differences between samples taken, one may want to make an additional correction. For those cases where many different plants were measured at many different temperatures we suggest converting to a standard temperature for a direct comparison or for publications. With HCFM Gen 3, the software computes the K25, the corrected conductance, adjusted again from the reading temperature to an equivalent conductance at 25 °C.

The temperature correction is approximately 2.4%/°C so if measurements are made over a range of 15 to 35 °C, stem conductances can change by 48%.

Below is the example of the transient measurement results. Each time the user performs a regression, the K, Kcorrected, and K25 are added to the data files as shown below.

Index	T (sec)	dT (sec)	P1 (kPa)	P2 (kPa)	dPaz (kPa)	Flow (kg/	Temp (De
1	0.0	0.0	2.5	1.4	0.1	0.0	26.1
12	25.7	2.3	132.0	78.1	53.7	0.0	26.2
13	28.1	2.3	143.5	85.4	58.0	0.0	26.2
14	30.4	2.3	155.0	92.6	62.3	0.0	26.2
15	32.7	2.3	166.5	99.8	66.6	0.0	26.1
16	35.1	2.3	177.9	106.9	71.0	0.0	26.2
17	37.4	2.3	189.4	114.1	75.3	0.0	26.2
18	39.7	2.3	200.8	121.3	79.6	0.0	26.2
19	42.1	2.3	212.2	128.4	83.9	0.0	26.2
20	44.4	2.3	223.7	135.6	88.2	0.0	26.2
21	46.8	2.3	235.0	142.7	92.4	0.0	26.2
22	49.1	2.3	246.4	149.9	96.7	0.0	26.2
23	51.4	2.3	257.8	157.0	101.0	0.0	26.2
K Value: 1.1939E-08 - R Square : 1.00000							
K Corrected : 1.3290E-08							
K 25 : 1.2986E-08							

Project folders contain the raw data from each experiment. The examples from earlier test data are also included as shown below on the CD ROM. Each file contains all of the data as well as your comments, calibration used, and the temperature corrected K values shown in the previous **Sections 7.2 and 7.3**.

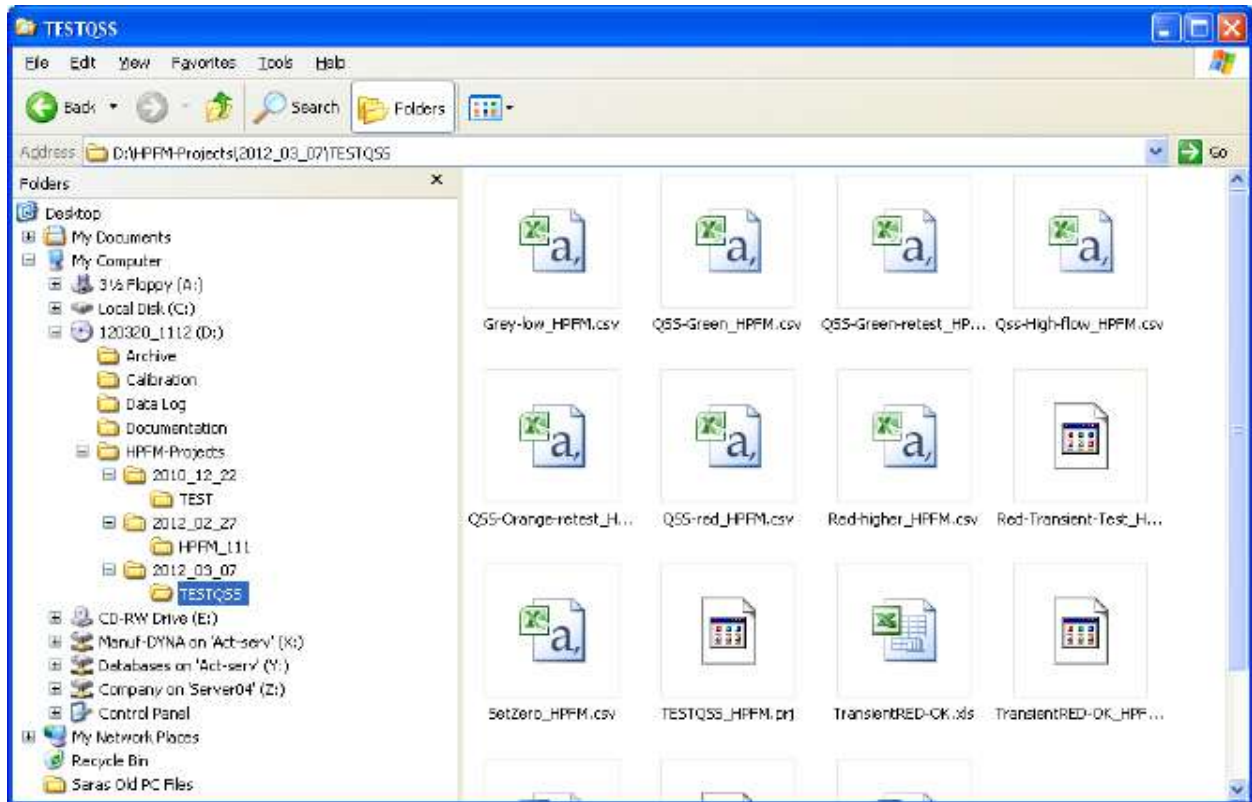

In the example below, the QSS data file is opened with excel, and converted directly from a .csv, to a file format that can be transferred to charts, or other analysis programs.

The screenshot shows Microsoft Excel (Trial) with the file 'Grey-low_HPFM.csv' open. The data is displayed in a table with the following columns and rows:

Index	T (sec)	dT (sec)	P1 (kPa)	P2 (kPa)	dPaz (kPa)	Flow (kg/	Cond (Kg/	Rest (sec	Temp (Deg C)
1	0		229.2264	-1.64717	229.698	0.000129	-0.07813	-12.7996	24.371
2	3.641		229.2353	-1.68243	229.7418	0.000129	-0.0765	-13.0716	24.372
3	7.094		229.2379	-1.69747	229.7594	0.000129	-0.07583	-13.1876	24.391
4	10.547		229.2426	-1.70421	229.7708	0.000129	-0.07553	-13.2395	24.379
5	13.969		229.2505	-1.73221	229.8064	0.000129	-0.07432	-13.4553	24.364
6	17.437		229.2301	-1.73947	229.7932	0.000129	-0.07401	-13.5123	24.378
7	20.89		229.2411	-1.74154	229.8062	0.000129	-0.07392	-13.5278	24.37
8	24.297		229.2264	-1.77058	229.8204	0.000129	-0.07271	-13.7527	24.361
9	27.75		229.2379	-1.78043	229.8417	0.000129	-0.07232	-13.8282	24.376
10	31.187		229.2489	-1.7965	229.8686	0.000129	-0.07168	-13.9518	24.369

8.0 Obtaining Good Data, and Data Presentation

8.1 Wound Response (plugging of stems)

Frequently, the resistance of whole shoots will rise constantly while doing quasi-steady state measurements. This is generally due to natural wound responses. If the basal 3 to 5 cm is removed, most of the resistance increase is also removed. Many species do not plug at all. The best way to avoid plugging problems on species with rapid wound response is to do conductance measurements by transient. It is best to re-hydrate the shoot by perfusing at 400 to 500 kPa (58 to 73 PSI) for a few minutes, excise the lower 3 to 5 cm, and then do a transient. HOWEVER, large branches present other problems (see **section 8.2**).

8.2 Air evenly distributed in the wood of large branches.

Old wood in large branches sometimes contains a large volume of air in embellished wood and wood fiber cells. This causes the quasi-steady state estimate of shoot conductance to differ from the value determined by transient. When no air is present and the leaves are fully infiltrated with water, the values of conductance should agree within 1 or 2% when compared between quasi-steady state and transient methods. The transient values are higher than the quasi-steady state value because part of the water entering during the transient goes to compress the air bubble. But during quasi-steady state measurements, after 40 minutes of perfusion the bubbles are compressed to a 'quasi-equilibrium volume' where further volume change depends on the slow dissolution of the air in water. The dissolution proceeds slowly over many hours in large stems. Oak species contain lots of air in old wood so the transient conductance can be 2 to 4 times the quasi-steady state conductance. The quasi-steady state value is likely to be the most accurate value if stem plugging has not occurred. For more details see: Nardini, A., M.T. Tyree. 1999 Root and shoot hydraulic conductance of seven Quercus species. **Annals of Forest Science. 56: 371-377**

8.3 Cautions when measuring small flows/conductance or large resistances

The elasticity of the tube connecting the outlet of the HCFM to the object being measured can seriously affect the accuracy of measurements. Small conductance should be measured with small diameter and rigid connection tubes. It is always a good practice to measure flow versus pressure with a solid plug inserted in place of the object to be measured. Conductances are computed from the slope of F versus PT^2 . Plasticity of connection tubes may give a slight slope of F versus PT^2 when measured with a solid plug in place of the object to be measured. Small conductance should be corrected by subtracting the slope observed when doing a transient on a solid plug. The size of this correction is less when small conductances are measured with small diameter, rigid connecting tubes (Figure 12.)

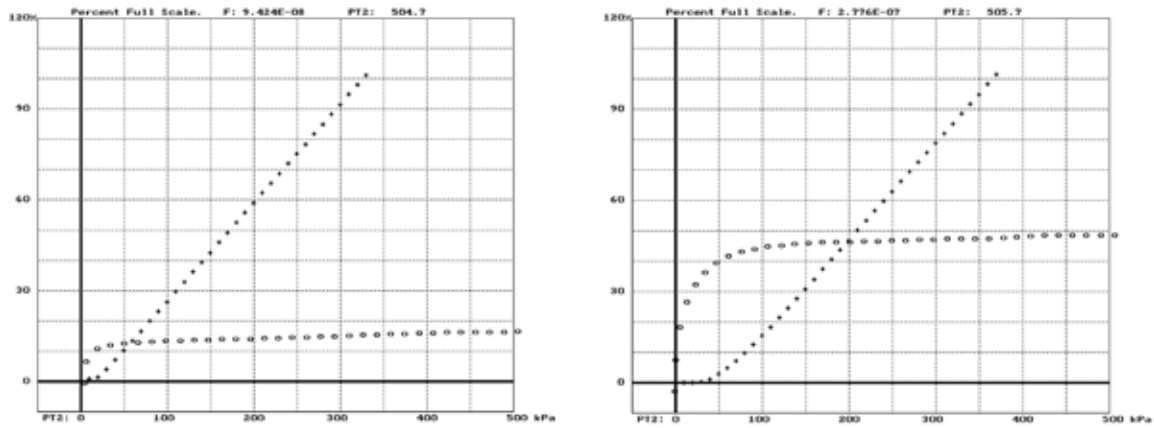

Figure 12
Comparison of transients measured on most sensitive range (Green range)

Flow was into a 1.5 m length of tubing connecting the 8WO to the smallest compression fitting connected to a solid plug 1.5 mm OD. For the graph on the left a 1.5 mm OD plastic tube was used on the right a 3 mm OD plastic tube. The higher plateau on the right is due to the higher elasticity of the larger tube. The slight slope on the plateaus may be due to minor leaks in the 8WO and the compression fittings or it might be due to non-linear elastic effects. Clearly the 1.5 mm tube is preferable for measurements of conductance of an unknown and the slight slope on the plateau should be subtracted from any conductance calculated on an unknown.

8.4 Air Bubbles

Air bubbles in the compression fitting or base of stem will influence the accuracy of conductance measurements, but cannot always be eliminated. Air bubbles are sometimes present in the stems or roots of plants and often cannot be eliminated. Generally, air bubbles can be eliminated from the HCFM. **Figure 13 & 14** show some typical transients with the influence of air bubbles.

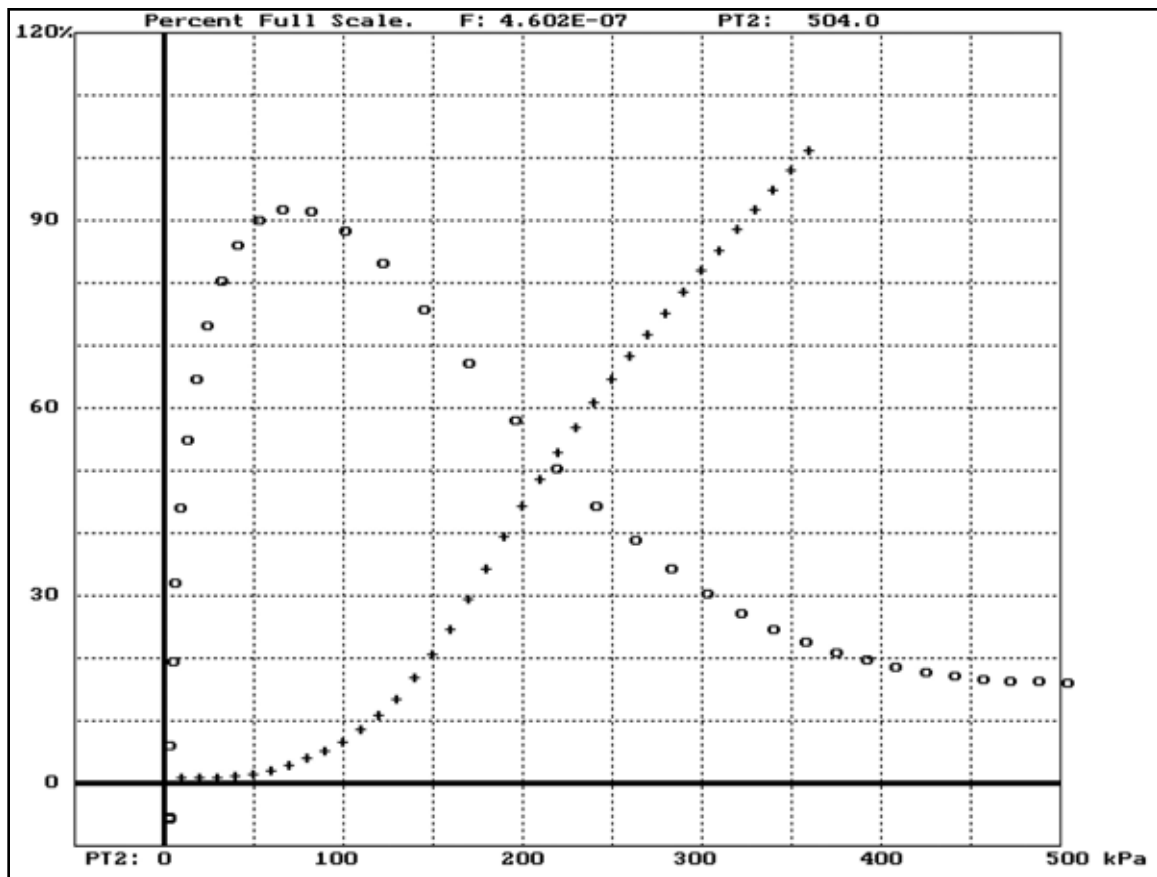

Figure 13
Transient done on the Orange range

NOTE: A linear transient line (Flow versus pressure) does not mean there is no air in the stems. When air is evenly distributed in the woody shoot, the transient can look quite linear and yet the value of conductance (= the slope) is too big. If the quasi-steady state and transient values of conductance show transient conductance more than 10% than the quasi-steady state value, then you probably have a stem with air more or less evenly distributed throughout the wood. In Figure 14, this transient has been done on a 1.5 m length of Red tube (0.12 mm ID). There is still a small air bubble present but the data are good enough to get a reliable conductance. The transient was collected on the Orange range. Figure 13 illustrates what the data look like when collected on the next higher (Red) range.

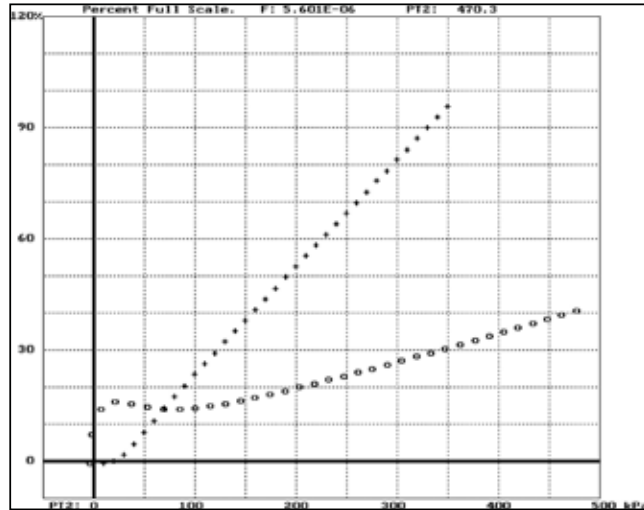

Figure 14
Transient collected on the Orange

Figure 15 is a repeat of the transient done above with a small air bubble in the 8W0 manifold. The transient was re-measured on the Red range. The slope of this curve should still give a valid conductance although the bubble can be eliminated completely.

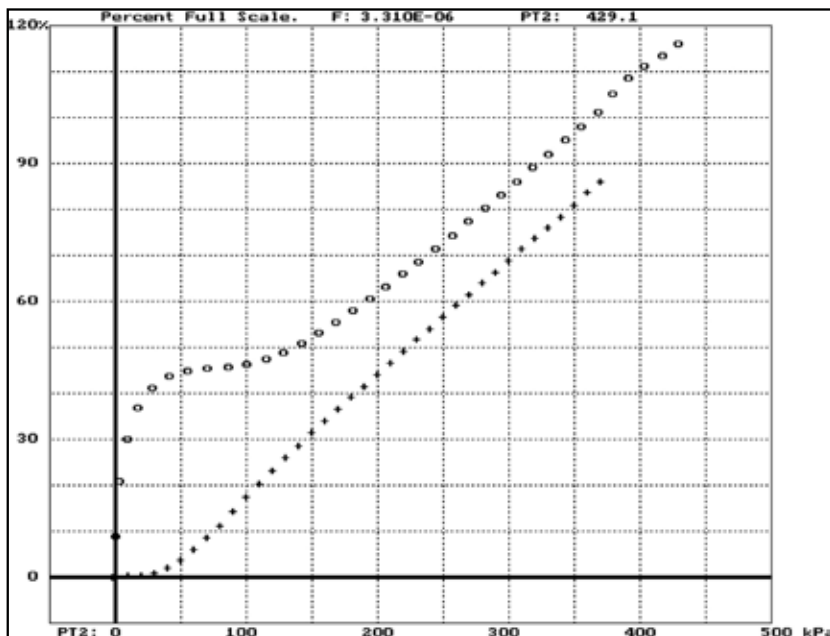

Figure 15
Transient re-measured on the Orange range

9. Connecting the HCFM to Roots and Shoots

SAFETY FIRST!

When working with tools, one should always consider safety. Razor blades can cut more than the xylem. So can saw blades. Being careful cannot protect you all the time. Wear gloves when using sharp objects. Make sure that you are cutting away from your body (and fingers) as well as away from other people. Wear safety glasses when using a saw blade. If you are in the field, and you are excising trees (or small parts of large trees), make sure that you wear the proper equipment, i.e., hard hats, steel-toed boots, when cutting. Other body protection may include sunscreen, long sleeved shirts full-length pants, and hearing protection. Also, consider the safety of those around you. Be aware of what you are doing and how it will affect the area around you and the people in that area. Are they wearing the proper safety attire? If you are in a lab, are they wearing proper protection as well?

Connecting the HCFM to Roots and Shoots

The HCFM, with practice, can be connected to the root, gather data, removed from the root and readied for travel in about 10 minutes. The HCFM can probably be connected to a shoot in less time than a root.

The steps for setting up a root or shoot are:

1. Measure the diameter of the sample where you plan to excise or cut the sample plant or tree. Make sure that there are no anomalies such as grafting scars, limbs, old limb scars, or excessive damage that might cause problems with the compression coupling creating a sealed system. Keep in mind that the largest object that the HCFM can be connected to is 50mm with the included compression couplings. Measure the object that you wish to sample and make sure that you are in range before excising the shoot or trunk! The larger sampled sizes, 40-50mm, will probably require the bark to be removed. Any rough surface that will affect the seal of the compression fitting will need to be removed or smoothed with sandpaper.



Photo 8
Cutting a Stem

2. Excise the shoot or cut down the trunk. Points to remember before and during the excise procedure are:

- a. Rough bark will need to be removed down to the xylem. This can be considered when measuring the sample. Even if the bark is smooth, water flow could move between the xylem and the bark, or between the bark and the compression coupling, the bark should be removed.

WARNING!

Do Not Remove the Xylem from the sample.

- b. When cutting a root sample, never cut the sample too low to the ground. If you are cutting a shoot sample, do not cut too close to a major stem. Give yourself plenty of room. Use the rubber compression seal from the compression coupling you plan to use to check the distance. The point to excise or cut should be:

- I. For sizes up to 20mm, leave 2-5mm of root stem above the top of the rubber compression seal.

II. For sizes from 20mm to 50mm, leave 5-10mm of root stem above the top of the rubber compression seal.

Note:

Check the distance below the rubber compression seal. Can you see leaks? Can you perform the installation of the coupling easily?

c. Cut or excise with a smooth level cut. The cut should always be perpendicular to the stem.

d. Use a razor blade (included with the HCFM) to remove the bark and related material to the depth of the cambium.

3. After having cut and prepared the stem, slip the nut and aluminum compression ring over the root stem. Make sure that the washer is as close to the size of the stem as possible. The aluminum compression ring should still be easy to slip on or off.



Photo 9
Removing bark from the stem

4. Place the rubber seal over the prepared area of the root stem. The seal should be snug, but should not have to be forced. If the compression seal is too small, use the next largest seal. If the rubber seal is too big, use a smaller one. The rubber seal should be applied with out a lubricant onto the sample and should have some light to moderate friction when twisted. Approx. 1cm of stem should be protruding from above rubber seal as shown in Photo 10. If not, go back to step 2 and remove more bark.



Photo 10
Installing the compression ring

WARNING!

BE CAREFUL with Knives, Razor Blades, Saws and other TOOLS.



Photo 11
Greasing the Coupling

5. Apply a light coating of the included G4 silicone grease to the threads of the head of the coupling as well as to the inside cone. The area inside the cone that requires the lubricant is where the compression seal will compress into the head by the nut. Again, a light coating is all that is required.

6. Compress the rubber compression seal into place by holding the coned head in place above the compression seal while tightening the nut into it. Do not move the head as the unit is being tightened, only the nut. Compress the nut until it is firm and there should be no fluid losses.

Note: that the root stem should stick out slightly (approx. 1cm) above the rubber compression seal. If it does not, remove the cone and compression fitting and remove more bark as per step 2. If the rubber compression seal closes around the end of the stem, then an inaccurate reading may occur.



Photo 12
Tightening the Coupling

CAUTION!

Make sure to apply a light coating of G4 Silicone grease to the outside surface of the rubber seal. This will prevent binding and eventual destruction of the seal and coupling surface.

7. Remove the HPLC compression-fitting cap (the colored tubing fitting at the top of the compression coupling). Be careful. There should be at least 2 small viton "O" rings inside the connection.

8. Take the Hypodermic syringe and fill the compression unit with de-gassed water. This water could come from the water carried in the Refill Kit apparatus.

Stick the needle down into the HPLC tubing connection of the cone and depress the hypodermic syringe filling the open area inside, displacing the air. As the air is replaced, use the needle to help remove air bubbles or pockets, using the velocity of the water moving out of the hypodermic needle. Once you have filled the open area of the compression fitting with water and have removed all the air, pull the hypodermic needle out while still depressing water out to fill the displacement of the needle itself.

Make sure that you have water on top of the open area of the HPLC connection with no air pockets below.

9. Note the tubing you are using. If you are using the smaller 1mm ID "Natural" HPLC tubing recommended for use with small compression coupling (1-20mm), then you will need two large viton "O" rings with one small viton "O" ring for connecting the tubing to the compression coupling. If you are using the larger 1.5mm Teflon clear tubing, you will only need the two larger "O" rings for connecting with larger couplings (19-50mm).



Photo 13
Removing Air from the Coupling

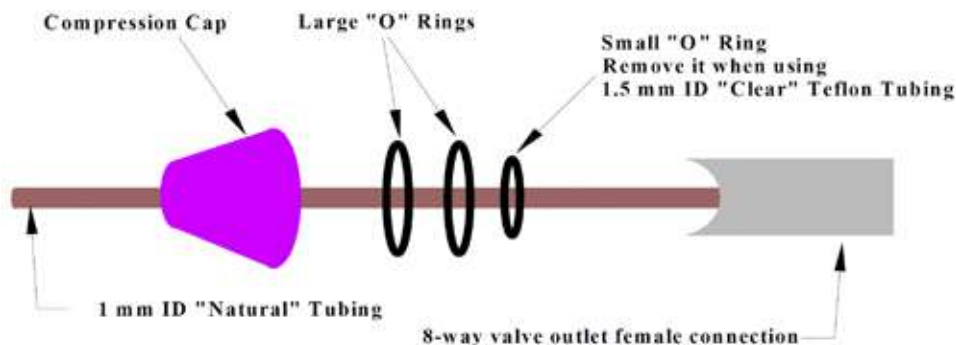

"O" Ring Layout Diagram

CAUTION!
Make sure that you do not have air in the compression coupling unit, the tubing leading to the compression unit, or in the HCFM.

The steps for connecting the tubing are:

- a. Carefully remove the “O” rings from the HPLC compression-fitting cap.
- b. To prevent FEP Teflon tubing from slipping, take the included razor blade and carefully rough up the end of the tubing where the viton “O” rings compress into the tubing. Slanted small scrapes seem to work best to hold. The more problematic slippage may require that you use a razor blade. Remember to keep the razor from slicing into the tubing or a finger.
- c. Place the HPLC compression-fitting cap on the tubing that you are using for your sampling.
- d. Make sure that the tubing is not constricted by previous compression in the fitting. If it is, use a razor blade to cut off a small part of the tubing.
- e. Place the necessary “O” rings on the tubing. If you are using the smaller tubing and require 3 “O” rings, place the smaller “O” ring on the tubing first, followed by the two larger “O” rings.
- f. Make sure that the pressure is >5 PSI (35 kPa). Open the valves on the HCFM, allowing the tubing to bleed the water at a slow drip as shown in photo 14 above. This will remove air from the tubing.



Photo 14
Connecting the “Clear” tubing w/2 larger “o” rings

- g. Place the tubing into the compression fitting on the top of the compression coupling and move the HPLC compression fitting cap down. Make sure that the tubing stays solidly inside the acrylic cone of the compression coupling.
- h. Make sure that you have water flowing and begin to screw the HPLC compression fitting cap into the compression fitting on top of the compression coupling. Make sure that it is snug, but do not over tighten. Two or three turns is all that is usually required after feeling the resistance of the “O” rings.

NOTE:
Excessive squeezing of the tubing by the compression fitting and “O” rings may restrict flow on the larger volume ranges of the HCFM.

- i. Water should have accumulated in the cracks and crevasses of HPLC compression fitting. Turn off the water flow by closing the Flow Out valve on the 8WO manifold. Turn the fitting cap until it is tight. Remember the warning above in step 9f.
- j. Give the tubing a slight pull to see if the tubing will stay in place. If it does, great go on to step 10. If not go to step 9b.

CAUTION!

Do not over tighten. Never use tools to tighten. You can compress the connection tubing, stopping the flow of water and give you erroneous results.

10. Open the flow out valve, making sure that there are no leaks. If there are leaks, repeat steps 7 through 9. If there are none, close the flow out valve and you are ready.

NOTE: A common problem with connecting large stems to compression fittings is that the fitting slips off during pressurization. One way to prevent this is to obtain a few small wood screws and screw 2 to 6 of them between the end of the stem and the upper surface of the rubber stopper. Leave the heads of the screws a few mm above the wood. This will prevent the stopper from slipping past the screws. The effect of the screws on the root or shoot conductance is very small! On smaller stems, too small for screws, try to make the cut at a nodal swelling and mount the stopper just below the swelling.

10. Disconnecting the HCFM

10.1 Valves Settings for moving the HCFM

The valve setting for moving a HCFM is simply in normally to leave the CAT tank pressurized and closing the outlet valve on the 8WO. The reason this deserves a section is that the valve position is important. The minimum required work, if these valves are not closed, is that the 8WI and 8WO manifold system will need to be bleed again. The maximum would be bleeding off all water and purging the air bubbles from the entire system!

10.2 Disconnecting and moving the HCFM

Specifically designed to be portable, the HCFM has several options that enhance this characteristic. One option is wheels and the other is a backpack frame to carry the HCFM into areas usually not accessible for research.

The HCFM, before moving, must be prepared. Preparation will keep the HCFM ready for the next sampling, keeping air pockets or bubbles from entering into the HCFM system. The steps for preparing the HCFM are:

- a. Close off the purple outlet valve on the 8WO and leave the CAT tank pressurized.
- b. Disconnect the Compression Coupling from the connecting tubing by loosening the HPLC cap on the coupling.
- c. Disconnect the tubing carefully holding the tubing above the height of the HCFM. This will minimize gravity loss of the water in the tubing and the connected HCFM system. One suggestion is to use a rubber band to hold the tubing to the frame.
- d. Remove the Compression Coupling from the sample by loosening the Compression Nut from the Coupling. Slip the acrylic housing off the Compression Seal.
- e. Slide the Compression Seal off the sample by twisting lightly as you pull the Seal off.
- f. Place the seal back into the Compression Coupling for storage.

11. Maintaining the HCFM

11.1 Changing the Water Filter

The HCFM water filter, under normal conditions, should be replaced annually. Under heavy loads, the filter should be replaced at least twice a year. To change the water filter follow these steps:

1. Release the compressed gas pressure making sure that the Captive Air Tank pressure is 0 PSI (0 kPa). This is accomplished by turning the Compressed Air Valve to the right, releasing the pressure slowly (1-1.5 PSI per second, 6.9-10 kPa per second).
2. Loosen the plastic strap that holds the water filter to the frame. It is not necessary to remove the steel strap. You should loosen the strap until you feel that the filter can slide up or down.
3. Loosen the steel clamp that holds the tubing to both ends of the water filter. Loosen the top strap first. Please be prepared for water to leak.
4. Pull the tubing off the top connection of the water filter. Use a slight twisting action while pulling backward. Hold the water filter firmly. After removing the connection, hold the tubing up to minimize the spillage of the degassed water. Also make sure that the steel clamp is in place for the new water filter.
5. Slide the filter down, removing the water filter from the strap that is binding it to the frame.
6. Hold the filter and with a slight twisting action remove the tubing from the bottom of the water filter. Make sure that the steel clamp is in place for the new water filter.
7. Check the flow direction arrows on the new water filter. Make sure that the water filter is installed in the right direction.
8. Take the new water filter and with a slightly twisting action push the filter on to the bottom tubing.
9. Slide the water filter into place. Tighten the plastic strap that holds the water filter to the frame. Also make sure that the water filter is in the same location as the old filter. This will make it easier to handle the tubing connections.
10. Using a slight twisting action push the tubing on to the top filter connection.
11. Tighten the two steel clamps that hold the tubing in place on the water filter.
12. Follow the instructions in **Section 4.5**, "*Eliminating Air from the HCFM.*"
13. Discard the old water filter properly, draining all the water from the old filter.

12. Calibration of the HCFM

Normally, the HCFM will not require frequent calibrations. A factory calibration is recommended every two years. Dynamax recommends that the calibrations only be performed by one of our fully trained technicians at the factory, or by one of the trained and fully qualified Dynamax distributors. During calibration all data is saved and supplied with each HCFM CD-Rom. The regression, and the calibration graphics are supplied and the documentation folder of the HCFM CD-Rom, and printed for your convenience. Below is the example of the calibration data and graphics.

Calibration Regression Data for HCFM-12-111 Tuesday, February 28, 2012

Calibration Factors:

NAME	A0 (mV)	A1 (mV/kPa)	A2 (mV/kPa ²)	A3 (mV/kPa ³)	A4 (mV/kPa ⁴)	A5 (mV/kPa ⁵)
P1	7.51203E-02	1.42340E-02	0.00030E-00	0.00000E03		
P2	1.11403E-01	1.43690E-02	0.00030E-00	0.00000E03		
ZERO	-7.71483E-01	-6.12920E-03	-1.34250E-05	9.56680E-08	-5.62880E-11	0.00000E00

NIST. Pressure Calibration against certificate number: C-1950

Date/Time 2/27/2012 12:07

Index	Pressure (kPa)	PT1 (mV)	PT2 (mV)
0	10.02	0.21382	0.2405
1	52.95	0.82739	0.86345
2	90.08	1.3564	1.40098
3	130.64	1.9355	1.98954
4	171.4	2.51592	2.57892
5	210.24	3.06891	3.13935
6	250.64	3.6454	3.72142
7	292.85	4.24646	4.32799
8	331.09	4.79199	4.87795
9	370.01	5.3308	5.42023
10	411.15	5.93252	6.02543
11	453.81	6.53818	6.63373
12	490.65	7.0611	7.15943
13	529.81	7.61586	7.71731
14	569.9	8.1795	8.28496

Signature Technician	_____
Signature Supervisor	_____
Date	_____

Green Range:

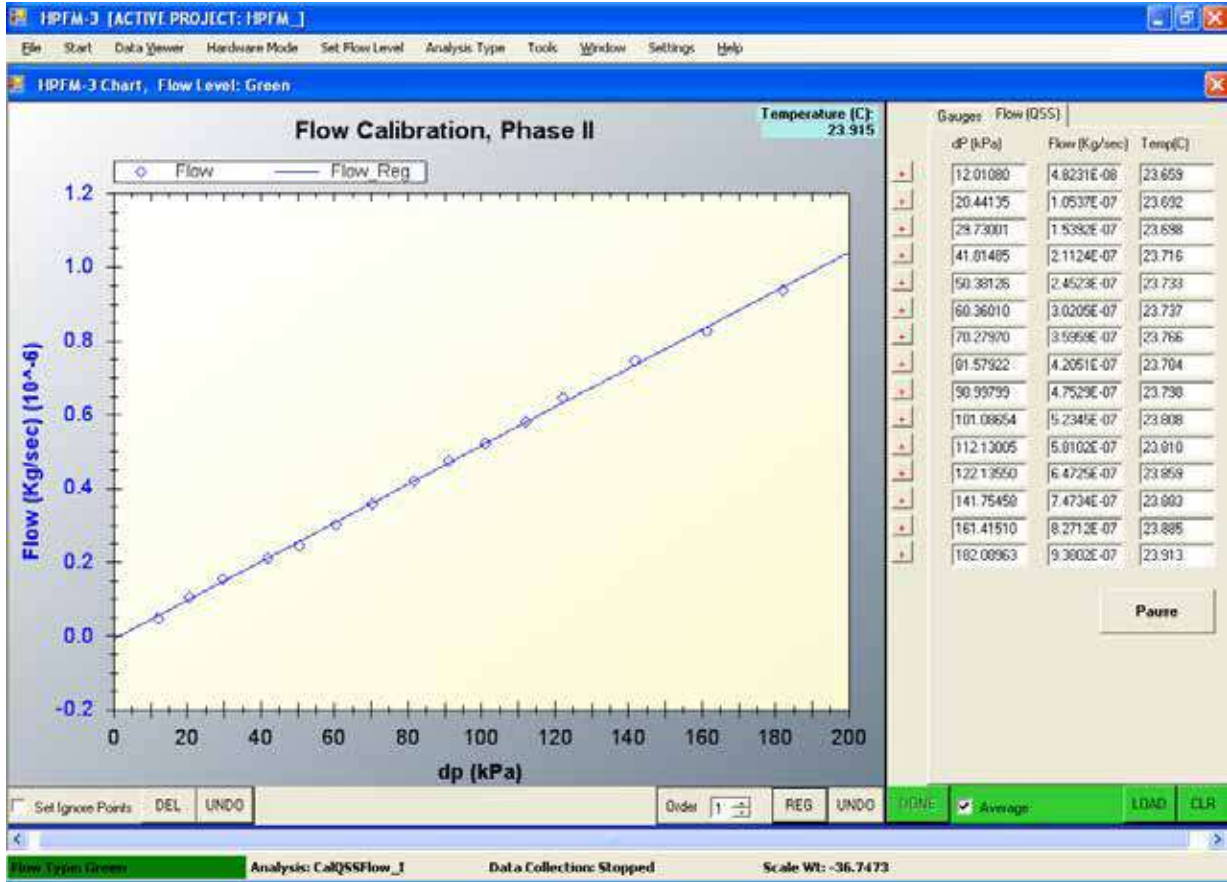
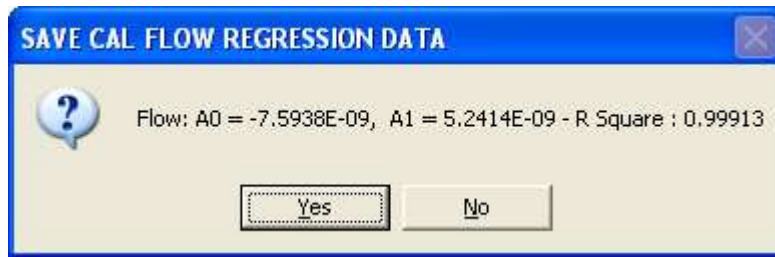

@ Zero flow evaporation at 4.73 e-09	Calculated A0 = -7.59 e-09
A0 with evaporation considered = -2.86 e-09	

Orange Range:

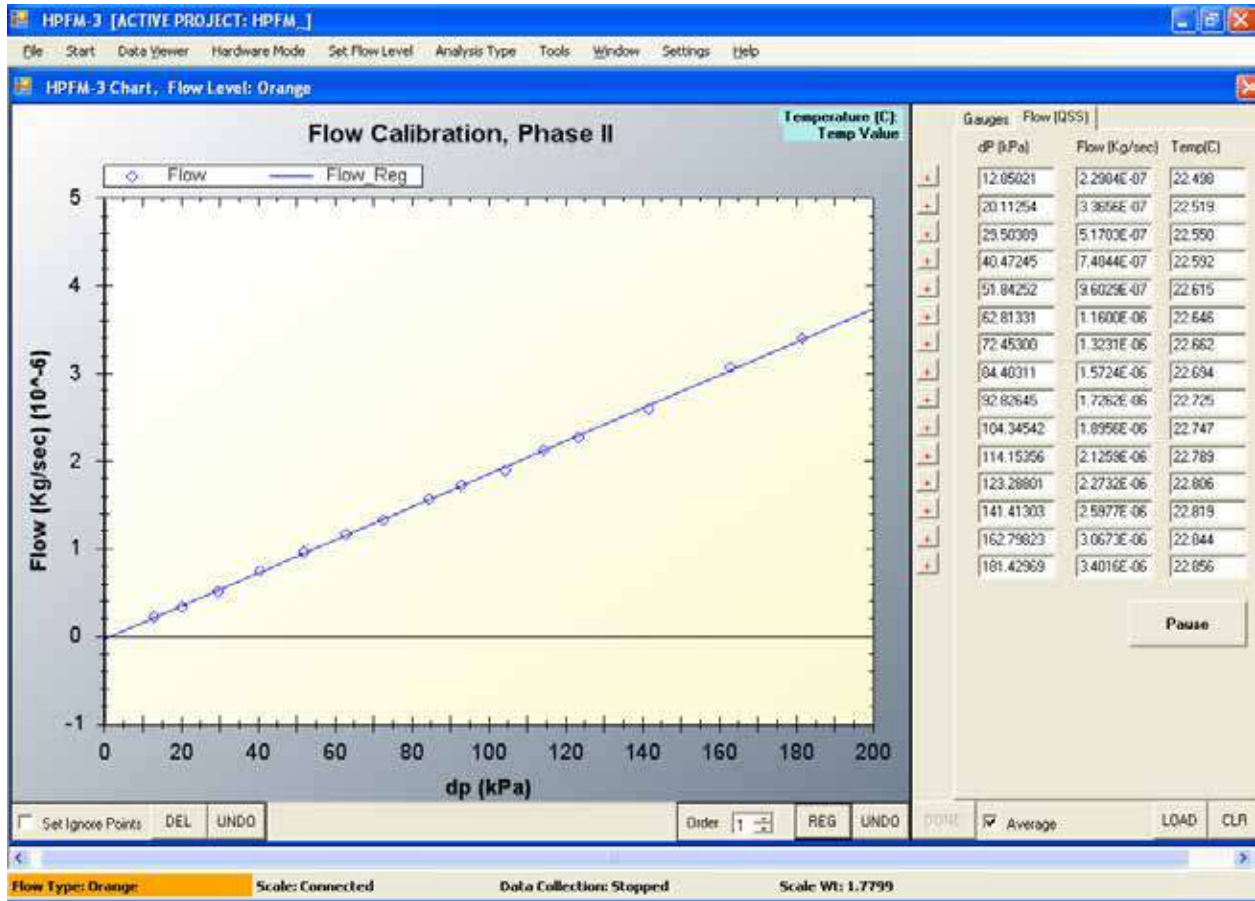
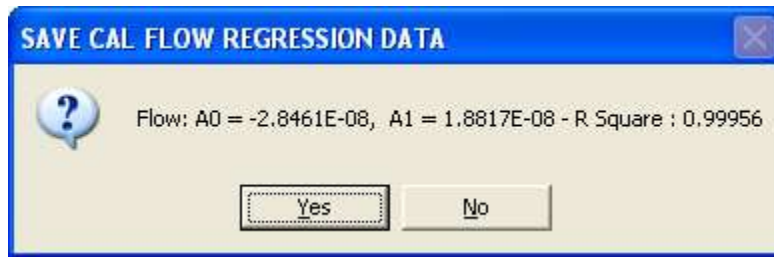

@ Zero flow evaporation at 4.73 e-09	Calculated A0 = -2.84 e-08
A0 with evaporation considered = -2.36 e-08	

Red Range:

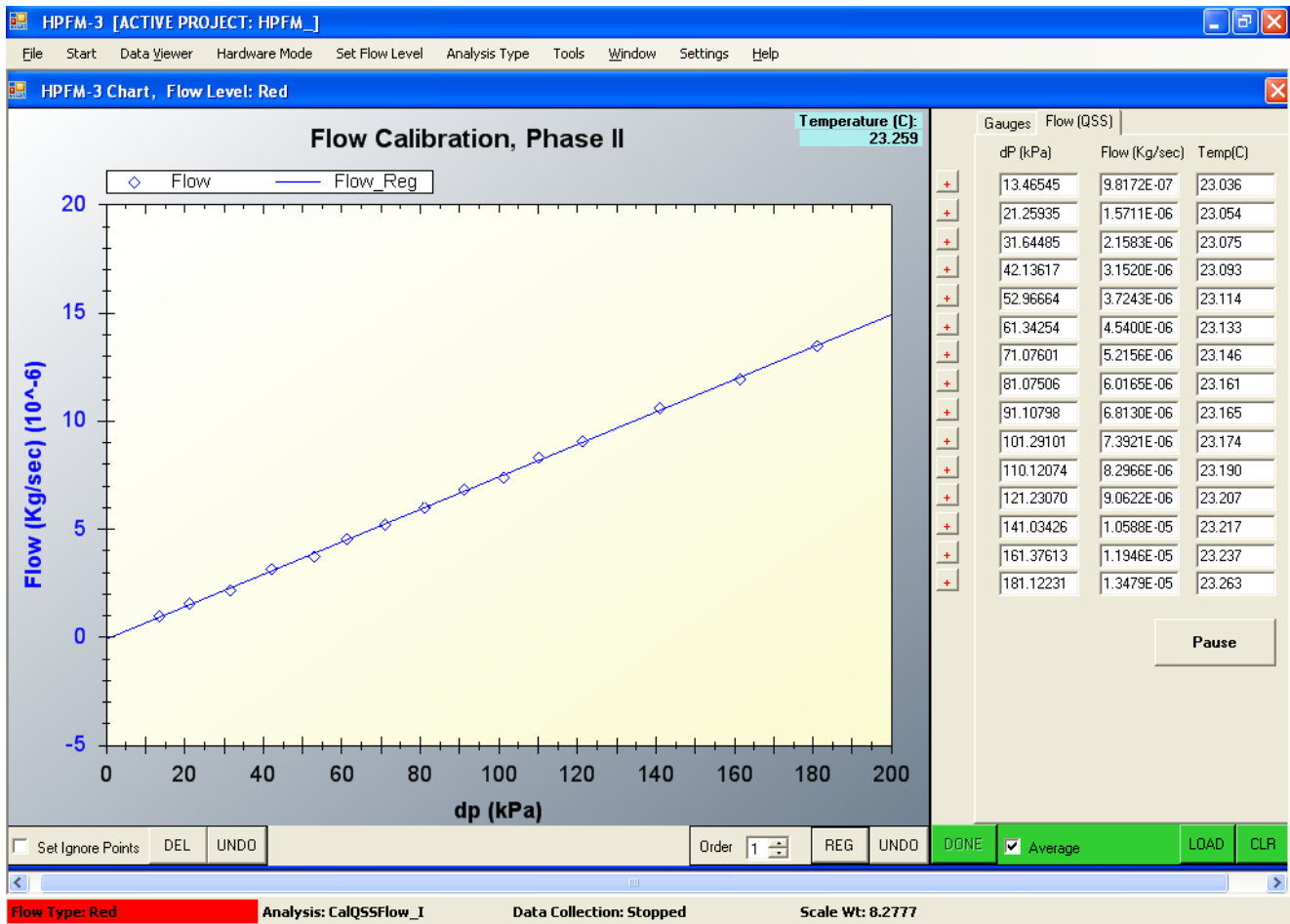
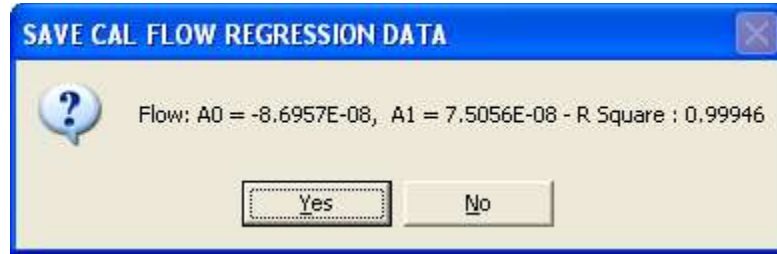

Yellow Range:

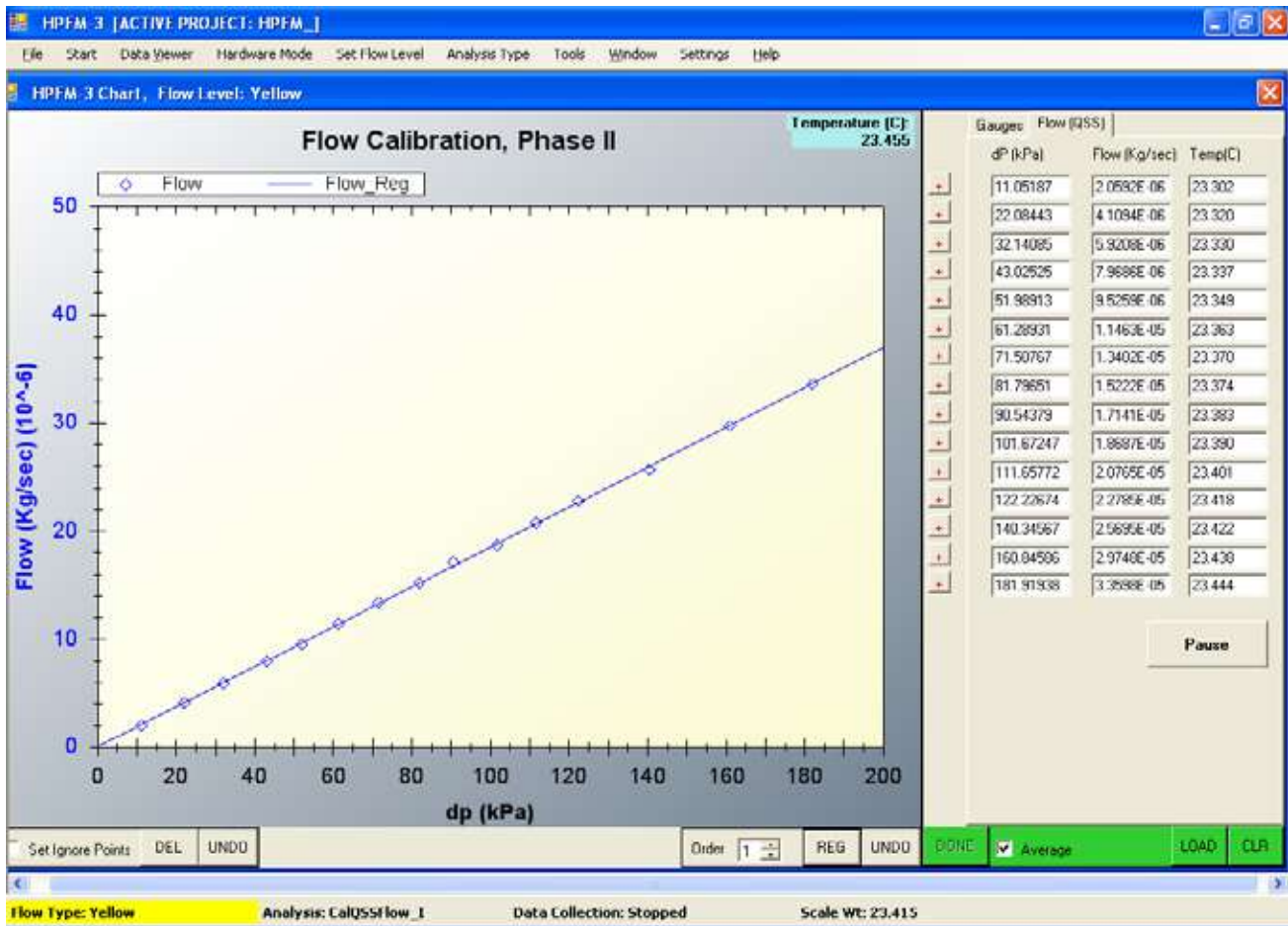
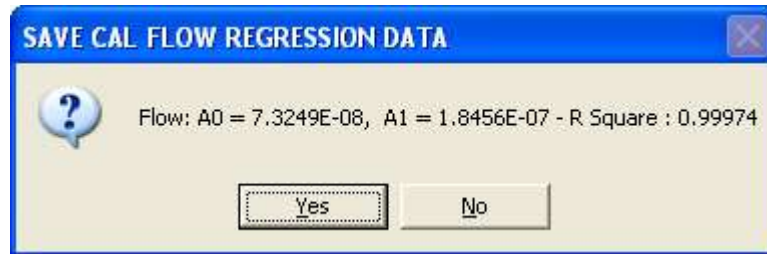

Grey Range:

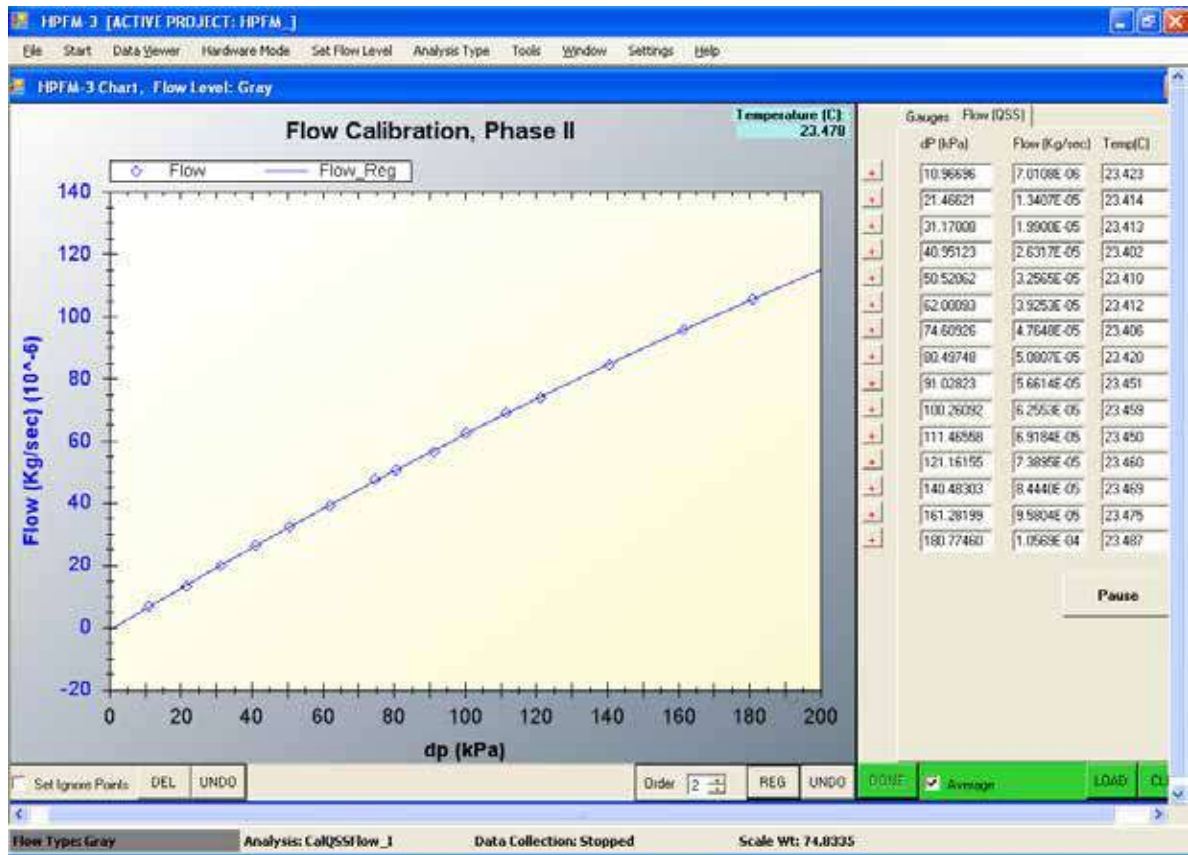
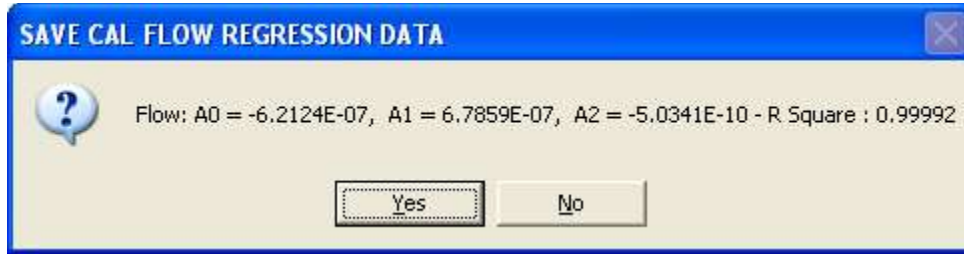

Brown Range:

SAVE CAL FLOW REGRESSION DATA

Flow: $A0 = 2.1076E-05$, $A1 = 4.5799E-06$, $A2 = -5.5419E-09$ - R Square : 0.99954

Yes No

HPFM-3 [ACTIVE PROJECT: HPFM_]

File Start Data Viewer Hardware Mode Set Flow Level Analysis Type Tools Window Settings Help

HPFM-3 Chart, Flow Level: Brown

Temperature (C): 23.574

Flow Calibration, Phase II

dP (kPa)	Flow (Kg/sec)	Temp(C)
13.06786	7.4212E-05	23.520
20.38595	1.0941E-04	23.516
31.07438	1.6249E-04	23.499
42.07145	2.0650E-04	23.497
50.40469	2.4030E-04	23.490
60.93236	2.7804E-04	23.492
71.27138	3.2541E-04	23.494
80.39392	3.5637E-04	23.491
91.08501	3.9319E-04	23.485
100.38520	4.2259E-04	23.498
110.76033	4.5946E-04	23.498
121.11513	4.8885E-04	23.509
141.21873	5.5241E-04	23.523
160.16206	6.1175E-04	23.524
181.81827	6.7570E-04	23.581

Flow (Kg/sec) (10^-6)

dp (kPa)

Flow (Kg/sec)

Temp(C)

Pause

Set Ignore Points DEL UNDO Order 2 REG UNDO DONE Average LOAD CLR

Flow Type: Brown Analysis: CalQ55Flow_I Data Collection: Stopped Scale Wt: 69.6564

Zero Adjustment Measurement:

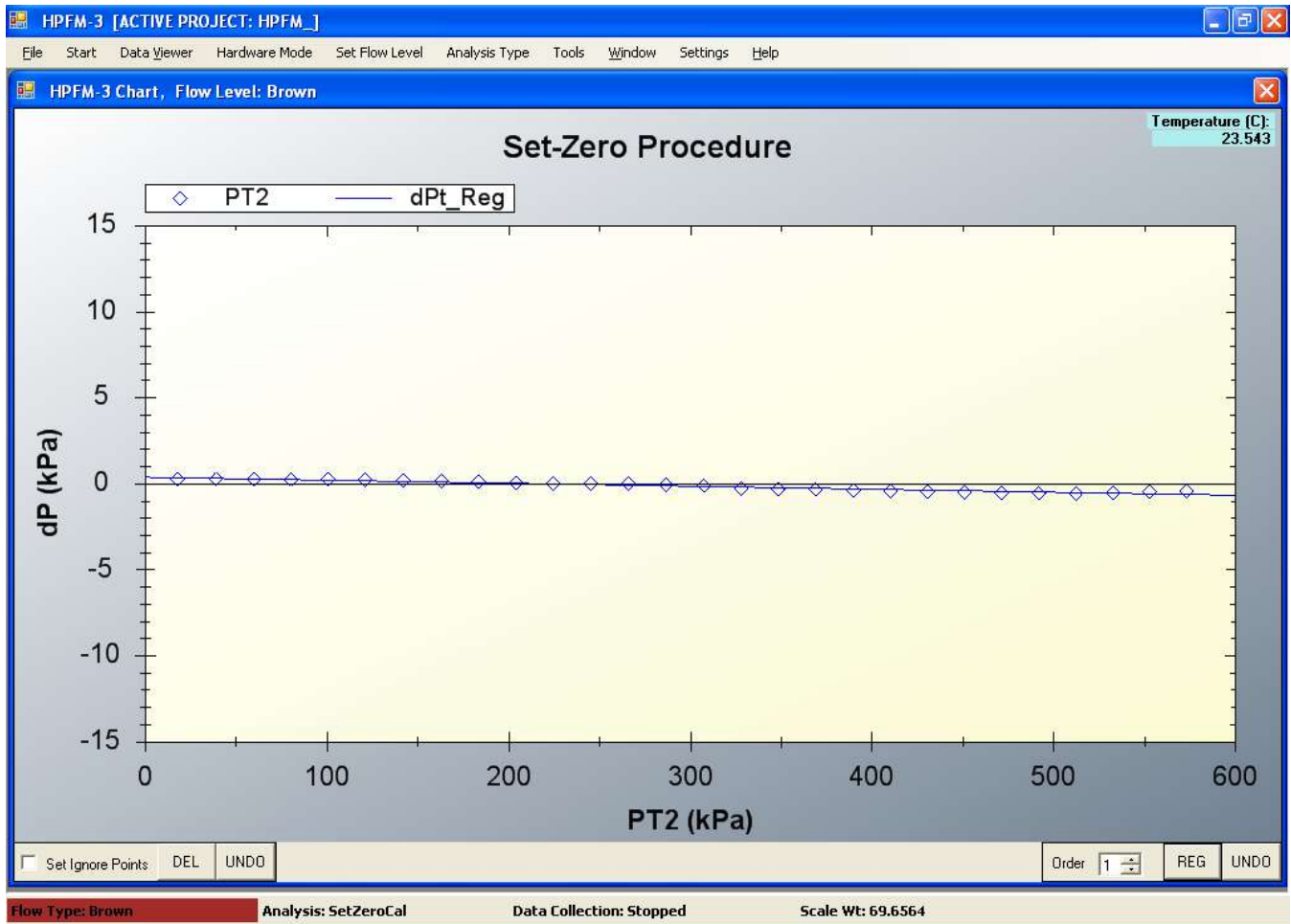
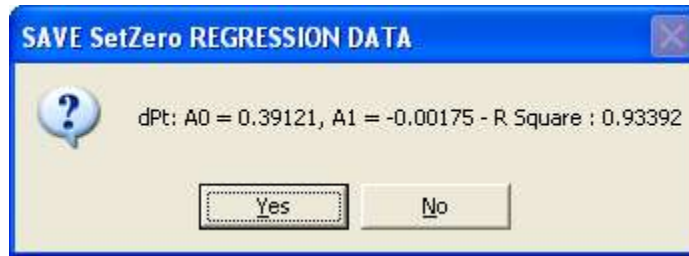

APPENDIX I Packing List

No.	Amount	Part No.	Description
1	1 unit	HCFM-XP	Standard HCFM unit
2	10	1401	Small o-rings
3	10	1402	Large o-rings
4	2	1310	Plastic compression caps
5	5 ft.	1535	(.005") I.D. x 1/16" O.D. "Red" Bleed Tubing
6	5 ft.	1540	(.042") 1 mm I.D. HPLC "Natural" Connection Tubing
7	6 ft.	CP-FT62	Teflon FEP C-9 Rigid "Clear" Connection Tubing
8	1	HPCC1-4 1001	1 - 4 mm two way connector
9	1	HPCC4-10 1008	4 mm - 10 mm universal connector
10	2	RSW502	Cone washer 3/8" for 8 - 10 mm range
11	1	HPCC10-20	10 - 20 mm compression coupling
12	1	HPCC19-36	19 - 35 mm compression coupling
13	2		10 - 20 mm aluminum compression rings
14	3		19 - 35 mm aluminum compression rings
15	6	#6 1/2	Coupling seals (drilled)
16	9	#10	Coupling seals (drilled)
17	1	G4	Silicone coupling assembly grease
18	1	MP2176	Air hose 5' with male couple, quick disconnect
19	1		Spare 9V battery
20	1		Refill Bottle
21	1		3 cc & 30 cc syringes with blunt needles & razor blade
22	2 oz.		Algaecide
23	1		Software CD
24	1		USB key lock
25	1		USB cable

APPENDIX II Bill of Materials

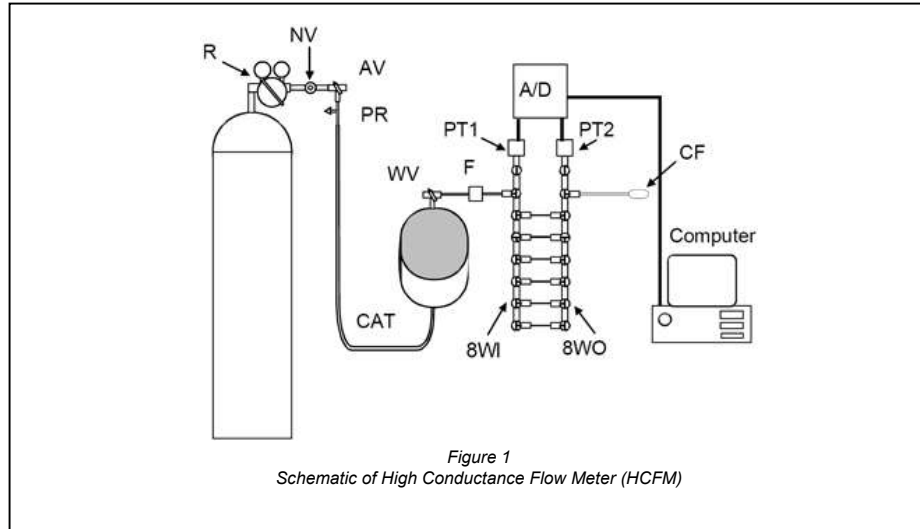

Bill of Materials

AV = Compressed Air Valve

WV = Water Valve

NV = Needle Valve

F = Water Filter

PC = Purge Cap on Water Filter (F)

CAT = Captive Air Tank

SB = supply box for storage of small parts and location of 12 VDC 4.5 Amp Hour Battery.

A/D = location of A/D circuit in the supply box.

PS = power switch to the A/D circuit.

OQ = orange quick fit Swagelok connector for adding water to the CAT.

GQ = red quick fit Swagelok connector for connection to Pressure Regulator.

PT1 = Pressure Transducer #1 on inlet side

PT2 = Pressure Transducer #2 on outlet side

8WI = 8-way manifold on inlet side

8WO = 8-way manifold on outlet side

IV = Flow Inlet Valve on inlet 8-way valve.

OV = Flow Outlet Valve on outlet 8-way valve.

DP = Digital Pressure Gage

SRV = Safety Release Valve that prevents the CAT from being pressurized more than 90 PSI.

Appendix III Trouble Shooting and FAQ

FAQ: When I use software to proceed in “SetZero” procedure, I got all points piled up together at beginning. What do I do?

Answer:

- Check if have all valves on manifolds closed except 2 valves for Brown range, 2 valves for pressure transducers and inlet valve.
- Check if you open the water switch by turning in switch to “Water In” position. Third, check if your system’s initial pressure is under 1 Psi = 6.895 kPa.
- Check if you have enough water inside your CAT in order to create a pressure to both transducers. If there is still no response on SetZero, restart your PC and HCFM. If everything is checked and you still receive the same SetZero result, contact Dynamax immediately for assistance.

FAQ: I try to do a “SetZero” procedure, but the system won’t response while I am increasing the pressure. Is there something wrong?

Answer: This is a Common problem.

- Let’s check your Calibration data. Please open your HCFM software by double clicking on the icon then go to “**File**” - “**View/Set Calib**” to show a screen of your calibration data. Refer to Picture 1 in the attached document. Most of your calibration data is different from this sample so please don’t intend to change yours unless instructed. Now, let’s take a look at your PT2 values: A0=-1.5219E-03 and A1=6.8965E-03. If your value is different, manually change to the above value by double clicking on them in your “**View/Set Calib**” screen and type in the correct values. Once it is changed, click on “**Save Values**” then “**Done**”. If they are the same, just click on “**Done**” to exit to the main screen.
- You need to check your PC readings on DP. In order to do so, you need to make sure the tank is at least half full, open all the valves on manifolds except outlet valve and open water valve as well (this usually being ignored and could cost you hours try to figure out why it didn’t work). Then, switch on your HCFM system and run HCFM software. Go to “**File**” – “**Calibrate HCFM**” – “**A/D Setup**” and click “**Start/Stop**”. Increase tank pressure to about 400 kPa and you will be able to see a reading in the window. The DP reading should be somewhere around 0 and PT2 reading should be around 30 mV. Then, close the inlet valve and open outlet valve. The reading should be DP=0 mV and PT2=0.2 mV. If, in both scenarios, the DP reading is + or – 24 out of range, you will need to re-Zero the board. But sometimes, this can be fixed by just adding some new water inside the tank. Then, you will have to bleed the tank for at least 6 hours before operating.
- Check each pressure transducer to see if they are working properly, which means if they output proper readings to your voltmeter.
- If you have gone through all these steps and still find no luck on running SetZero procedure, please contact Dynamax Technical Support on HCFM for further instruction. Please DO NOT disassemble any part of the system.

FAQ: We cannot save the regression values after performing the SetZero option. A “file access denied” box appears when we try to save the regression values.

Answer: This is caused, I assume, by saving your regression value on your calibration CD. If that is the case, please refer to HCFM manual **Section 5.1**, where ask you to copy your HCFM.ini and HCFM_CAL_DATA.ini files from the CD to your Harddrive where you install the HCFM program. If this is not the case, you will need to check if you have specified correct path of your HCFM.CAL file. If not, use option File-NewCalfile to specify the location of your HCFM.CAL file. Then perform Setzero and regression. If you keep experiencing the same problem, please contact Dynamax for further assistance.

APPENDIX IV - Reference List

43. Tyree, M.T., Patino, S., Benink, J., Alexander, J., (1994). *Dynamic measurements of root hydraulic conductance using a high-pressure flowmeter in the laboratory and field.* Journal of Experimental Botany, Vol. 46, No. 282, pp. 83 - 94.

A new high-pressure flowmeter (HCFM) is described that is capable of rapid water-flow measurements. This article describes the HCFM, presents the theory of dynamic flow measurements, discusses sources of error, presents evidence that dynamic measurements of K_r in *Ficus maclellandi* (and six other tropical species from Panama) yield the correct result, and demonstrates the use of the method under field conditions in Panama on *Cecropia obtusifolia* and *Palicourea guianensis*.

51. Zotz, G., Tyree, M.T., Carlton, M.R., (1998). *Hydraulic architecture and water use of selected from a lower montane forest in Panama.*, Trees, No. 477, pp. 1 - 8.

Plant water relations of nine woody species were studied in a lower montane rain forest in Panama. This data provides a partial test of the hypothesis that hydraulic architecture of lower montane species might limit transpiration and thus leaf size or nutrient transport (as suggested by J. Cavelier and E.G. Leigh, respectively). Another objective of this study was a comparison of two different methods to measure hydraulic conductance and leaf specific conductance of stem segments.

52. Tyree, M.T., 1997. The Cohesion-Tension theory of sap ascent: current controversies., Journal of Experimental Botany, Vol. 48, No. 315, pp. 1753 - 1765.

In recent years, the Cohesion-Tension theory of sap ascent in plants has come under question because of work published by Professor Ulrich Zimmermann and colleagues at the University of Würzburg, Germany. The purpose of this review is to state the essential and testable elements of the C-T theory, summarize the negative evidence for the C-T theory, and review critically the positive evidence for the C-T theory and the evidence that the Scholander-Hammel pressure bomb measures xylem pressure potential (P_x) correctly, because much of the evidence for the C-T theory depends on pressure bomb data.

55. Tsuda, Makoto and Tyree, M.T., (1997). *Whole-plant hydraulic resistance and vulnerability segmentation in *Acer saccharinum*.*, **Tree Physiology Vol. 17, pp. 351 - 357.**

Hydraulic properties were studied in *Acer saccharinum* L., a riparian species that also grows well on a dry soil when transplanted. Hydraulic resistances were measured by two independent techniques: a new high-pressure flowmeter (HCFM) method and a conventional evaporative flux (EF) method. Vulnerability to cavitation was also investigated on petioles, stems and roots using hydraulic conductivity technique.

70. Tyree, M.T., Velez, Virginia, Dalling, J.W., (1998). Growth dynamics of roots and shoot hydraulic conductance in seedlings of five neotropical tree species: scaling to show possible adaptation to differing light regimes. Oecologia Vol. 114, pp. 293 - 298.

The dynamics of growth (shoot and root dry weights, surface areas, hydraulic conductances, and root length) were measured in seedlings of five neotropical tree species aged 4-16 months. The species studied included two light-demanding pioneers and three shade-tolerant young or old forest species. Growth analysis revealed that shoot and root dry weights, hydraulic conductances and leaf area all increased exponentially with time. The advantages of scaling hydraulic parameters to leaf surface area are discussed in terms of the Ohm's law analogue of water flow in plants.

71. Tyree, M.T., Sobrado, M.A., Stratton, L.J. (1998). *Diversity of Hydraulic conductance in leaves of temperate and tropical species: Possible causes and consequences.* Journal of Tropical Forest Science.

Liquid-flow-pathway hydraulic conductances (K_l) were measured in leaves of 24 species of temperate and tropical plants. Whole shoot conductances were measured by transient (K_l) and quasi-steady state (K_q) methods. Implications of low leaf conductances on the measurement of xylem pressure potential with a Scholander-Hammel pressure bomb are also discussed.

79. Cochard, H., Martin, R., Gross, P., Bogeat-Triboulot, M.B. (2000). Temperature effects on hydraulic conductance and water relations of Quercus robur L. Journal of Experimental Botany, Vol. 51, No. 348, pp. 1255 - 1259.

The effects of temperature on root and shoot hydraulic conductances were investigated for Quercus robur L. saplings. In the first experiment, conductances were measured with the HCFM on excised shoots and detopped root systems. In the second experiment, the impact of temperature-induced changes in groot on sapling transpiration (E) and leaf water potential was assessed. Intact plants were placed in a growth cabinet with constant air and variable soil temperatures. The results illustrate the significance of gplant for the stomatal control of transpiration and the significance of temperature for tree water transport.

APPENDIX IV – Glossary

A/D

The output of the pressure transducers is logged using a custom-designed, dual channel A/D circuit with 12 bits plus sign accuracy. The location of A/D circuit in the supply box. The HCFM is supplied with Windows software for controlling the A/D circuits, logging data, and for preliminary data analysis.

Air Valve, AV

Capillary Tubes, CT

The capillary tubes are 1.5 mm OD HPLC tubing 0.16 to 1.5 m in length.

Captive Air Tank, CAT

The Captive Air Tank (CAT) is a two-compartment tank. The upper compartment contains water and the lower section can be pressurized with air. A flexible rubber diaphragm separates the two compartments. The large stainless steel CAT allows you to pressurize the water without the air and water mixing together. The CAT will hold 7.0 liters of water and it is best to refill while there is still at least 0.5 liters of water in the tank. The Captive Air Tank (CAT) should be filled only with 'degassed water', i.e., water with air dissolved at less than saturating concentrations of O₂ and N₂ at atmospheric pressure. It is important to prevent air bubbles from entering the Captive Air Tank (CAT) because these bubbles will re-saturate the degassed water.

Cubic Feet, Cu. Ft.

The compressed air tank for the HCFM has a volume of 24 cubic feet.

Differential pressure, dP

Water flow across the selected CT causes a differential pressure (dP) drop ($dP = P_1 - P_2$) measured with PT1 and PT2, respectively. If the software recognizes that the differential pressure between PT1 and PT2 is over 18 milli-volts or 18 PSI (124 kPa), then it will give you a message telling you that the HCFM is out of range. The working range for the differential pressure is 0 to 18 milli-volts. The desired range is 8 to 15 milli-volts. When you are working with root systems, the differential pressure will normally increase the longer you have the HCFM coupled to the root.

DT

DW

Water Filter, F

Flow to compress air bubbles, Fb

Elastic flow, Flow associated with elastic swelling, Fe

In order to reduce elastic flow, Fe, always use small-diameter, rigid outlet tubing when using the two lowest flow rate ranges (Green and Orange).

Rate of passage through the roots, Fh

If the flow through the object measured is a linear function of applied pressure difference between the outlet of the HCFM and atmospheric pressure.

GQ

Green quick fit connector for adding air to CAT.

Hydraulic Conductance

It is an apparatus designed to perfuse water into an object while rapidly changing the delivery pressure and simultaneously measuring flow. The slope of flow plotted versus pressure equals the hydraulic conductance of the object. While measurement of the Transient is simply graphing a line of increasing pressure and flow, Regression is the “best fit” of that graphical line and calculating the slope. That slope is the hydraulic conductance of the measured plant.

Hypodermic syringe

Air must be removed by disconnecting PT2 from the 8WO and injecting water using a hypodermic needle and syringe. The HCFM comes with a hypodermic syringe that has a blunt point “needle.”

Inside Diameter, ID

The inside diameter that is 9 mm of a nylon-reinforced Tygon tubing where pressurized water flows from the CAT to the 8-Way Inlet manifold (8WI).

Flow Inlet Valve, IV

on inlet 8-way valve.

K

uncorrected conductance

kPa

Measurement for pressure in Kilo-Pascal's

K root conductance, Kr**KCT**

Conductance of the capillary tubes.

LPT1, LPT2, or LPT3

A connection used to connect the HCFM to a PC. When the HCFM program starts, the program automatically tests for basic communication with the HCFM by testing to see if the HCFM is connected to the computer through one of three possible printer port connections.

Mpa

Measurement for pressure

MohmsMV

Measurement in milli-volts

n

the number of moles of gas in the bubble

Needle Valve, NV

Used to regulate the rate of increasing pressure. The rapid change in water pressure is achieved using the needle valve. Through the needle valve, the pressure regulator keeps the compressed air at a steady pressure of 4 to 5 MPa (580-725 PSI).

Outside Diameter, OD**OQ**

Orange quick fit connector for adding water to CAT.

OV

Flow Outlet Valve on outlet 8-way valve.

Pi
Initial gas pressure.

PSI
Measurement of pressure in pounds per square inch.

P2
The outlet pressure relative to atmospheric pressure applied pressure.

Purge Cap, PC
Air is purged using the red purging caps located on the top and the bottom of the filter near the outer edge of the round body of the filter.

PR
Pressure Regulator that prevents accidental over-pressurization.

Pressure transducers, PT1
Pressure Transducer #1 on inlet side.

Pressure transducers, PT2
Pressure Transducer #2 on outlet side.

Power switch, PS
to the A/D circuit.

Purge Valve, PV

Pressure Regulator, R
Delivers compressed air from the compressed air tank (AT).

Quasi-steady State Measurements of Hydraulic Resistance, RQS
During steady-state measurements of RQS, water flow and applied pressure are both constant and by definition the water flow into the object measured equals the flow out of the object.

Unknown hydraulic resistance, RU
The unknown hydraulic resistance of a quasi-steady state measurement.

Supply Box, SB
For storage of small parts and location of 12 VDC 4.5 Amp Hour Battery.

Safety Release Valve, SRV
Prevents the CAT from being pressurized more than 90 PSI.

T
The Kelvin temperature at which K was measured.

μm
Initial volume, V_i

viton "O" rings
When removing the HPLC compression-fitting cap (the colored tubing fitting at the top of the compression coupling), there should be at least 2 small viton "O" rings inside the connection.

Volume of the system, V

V_o
The initial volume of the system at $P_2 = 0$

Vb

The volume of a bubble at absolute gas pressure P_b

Water Valve, WV

Allows water flow into the filter and subsequently into the valve manifold (8WI and 8WO) system at $P_2 = 0$.

8WI

An Omnifit, 8-Way, HPLC valve of octagonal geometry with 8-tubes emerging from a common point in the center and each tube terminated by a valve.

8WO

An 8-way manifold on outlet side